

* The illustration shows the TD-15.

TD-15 TD-11

DRUM SOUND MODULE

Owner's Manual

Roland

How to obtain a PDF of the owner's manual

PDF files of the owner's manual and supplementary material for this product can be obtained from the Roland website.

- TD-15/TD-11 Owner's Manual (this document)
- Data List
(This is not included with the product; you may download it as necessary.)

Visit the following URL, choose "Owner's Manuals," and search for the model name "TD-15" or "TD-11."

<http://www.roland.com/support/en/>

USING THE UNIT SAFELY

Before using this unit, carefully read the sections entitled: "USING THE UNIT SAFELY" (p. 2) and "IMPORTANT NOTES" (p. 4). These sections provide important information concerning the proper operation of the unit. Additionally, in order to feel assured that you have gained a good grasp of every feature provided by your new unit, Owner's manual should be read in its entirety. The manual should be saved and kept on hand as a convenient reference.

INSTRUCTIONS FOR THE PREVENTION OF FIRE, ELECTRIC SHOCK, OR INJURY TO PERSONS

About ⚠ WARNING and ⚠ CAUTION Notices

⚠ WARNING	Used for instructions intended to alert the user to the risk of death or severe injury should the unit be used improperly.
⚠ CAUTION	Used for instructions intended to alert the user to the risk of injury or material damage should the unit be used improperly. * Material damage refers to damage or other adverse effects caused with respect to the home and all its furnishings, as well to domestic animals or pets.

About the Symbols

	The ⚠ symbol alerts the user to important instructions or warnings. The specific meaning of the symbol is determined by the design contained within the triangle. In the case of the symbol at left, it is used for general cautions, warnings, or alerts to danger.
	The symbol alerts the user to items that must never be carried out (are forbidden). The specific thing that must not be done is indicated by the design contained within the circle. In the case of the symbol at left, it means that the unit must never be disassembled.
	The symbol alerts the user to things that must be carried out. The specific thing that must be done is indicated by the design contained within the circle. In the case of the symbol at left, it means that the power-cord plug must be unplugged from the outlet.

ALWAYS OBSERVE THE FOLLOWING

WARNING

Do not disassemble or modify by yourself

Do not open (or modify in any way) the unit or its AC adaptor.



Do not repair or replace parts by yourself

Do not attempt to repair the unit, or replace parts within it (except when this manual provides specific instructions directing you to do so). Refer all servicing to your retailer, the nearest Roland Service Center, or an authorized Roland distributor, as listed on the "Information" page.



Do not use or store in the following types of locations

- Subject to temperature extremes (e.g., direct sunlight in an enclosed vehicle, near a heating duct, on top of heat-generating equipment); or are
- Damp (e.g., baths, washrooms, on wet floors); or are
- Exposed to steam or smoke; or are
- Subject to salt exposure; or are
- Humid; or are
- Exposed to rain; or are
- Dusty or sandy; or are
- Subject to high levels of vibration and shakiness.



WARNING

Use only Roland stand MDS series that is recommended

This unit should be used only with a stand that is recommended by Roland.



Do not place in an unstable location

When using the unit with a stand recommended by Roland (MDS series), the stand must be carefully placed so it is level and sure to remain stable. If not using a stand, you still need to make sure that any location you choose for placing the unit provides a level surface that will properly support the unit, and keep it from wobbling.



Use only the included AC adaptor and the correct voltage

Be sure to use only the AC adaptor included with the unit. Also, make sure the line voltage at the installation matches the input voltage specified on the AC adaptor's body. Other AC adaptors may use a different polarity, or be designed for a different voltage, so their use could result in damage, malfunction, or electric shock.



Use only the included power cord

Use only the attached power-supply cord. Also, the included power cord must not be used with any other device.



WARNING

Do not bend the power cord or place heavy objects on it

Do not excessively twist or bend the power cord, nor place heavy objects on it. Doing so can damage the cord, producing severed elements and short circuits. Damaged cords are fire and shock hazards!



Avoid extended use at high volume

This unit, either alone or in combination with an amplifier and headphones or speakers, may be capable of producing sound levels that could cause permanent hearing loss. Do not operate for a long period of time at a high volume level, or at a level that is uncomfortable. If you experience any hearing loss or ringing in the ears, you should immediately stop using the unit, and consult an audiologist.



Don't allow foreign objects or liquids to enter unit; never place containers with liquid on unit

Do not place containers containing liquid on this product. Never allow foreign objects (e.g., flammable objects, coins, wires) or liquids (e.g., water or juice) to enter this product. Doing so may cause short circuits, faulty operation, or other malfunctions.



WARNING

Turn off the unit if an abnormality or malfunction occurs

Immediately turn the unit off, remove the AC adaptor from the outlet, and request servicing by your retailer, the nearest Roland Service Center, or an authorized Roland distributor, as listed on the "Information" page when:



- The AC adaptor, the power-supply cord, or the plug has been damaged; or
- If smoke or unusual odor occurs; or
- Objects have fallen into, or liquid has been spilled onto the unit; or
- The unit has been exposed to rain (or otherwise has become wet); or
- The unit does not appear to operate normally or exhibits a marked change in performance.

Adults must provide supervision in places where children are present

When using the unit in locations where children are present, be careful so no mishandling of the unit can take place. An adult should always be on hand to provide supervision and guidance.



Do not drop or subject to strong impact

Protect the unit from strong impact. (Do not drop it!)



Do not share an outlet with an unreasonable number of other devices

Do not force the unit's power-supply cord to share an outlet with an unreasonable number of other devices. Be especially careful when using extension cords—the total power used by all devices you have connected to the extension cord's outlet must never exceed the power rating (watts/amperes) for the extension cord. Excessive loads can cause the insulation on the cord to heat up and eventually melt through.



Do not use overseas

Before using the unit in a foreign country, consult with your retailer, the nearest Roland Service Center, or an authorized Roland distributor, as listed on the "Information" page.



Do not use a CD-ROM in an audio CD player or DVD player

DO NOT play a CD-ROM disc on a conventional audio CD player. The resulting sound may be of a level that could cause permanent hearing loss. Damage to speakers or other system components may result.



CAUTION

Place in a well ventilated location

The unit and the AC adaptor should be located so their location or position does not interfere with their proper ventilation.



Use only the specified stand (s)

This unit is designed to be used in combination with specific stands (MDS series) manufactured by Roland. If used in combination with other stands, you risk sustaining injuries as the result of this product dropping down or toppling over due to a lack of stability.



Evaluate safety issues before using stands

Even if you observe the cautions given in the owner's manual, certain types of handling may allow this product to fall from the stand, or cause the stand to overturn. Please be mindful of any safety issues before using this product.



Grasp the plug when connecting or disconnecting the AC adaptor

Always grasp only the plug on the AC adaptor cord when plugging into, or unplugging from, an outlet or this unit.



Periodically clean the AC adaptor's plug

At regular intervals, you should unplug the AC adaptor and clean it by using a dry cloth to wipe all dust and other accumulations away from its prongs. Also, disconnect the power plug from the power outlet whenever the unit is to remain unused for an extended period of time. Any accumulation of dust between the power plug and the power outlet can result in poor insulation and lead to fire.



Manage cables for safety

Try to prevent cords and cables from becoming entangled. Also, all cords and cables should be placed so they are out of the reach of children.



Avoid climbing on top of the unit, or placing heavy objects on it

Never climb on top of, nor place heavy objects on the unit.



CAUTION

Do not connect or disconnect the AC adaptor with wet hands

Never handle the AC adaptor or its plugs with wet hands when plugging into, or unplugging from, an outlet or this unit.



Disconnect everything before moving the unit

Before moving the unit, disconnect the AC adaptor and all cords coming from external devices.



Unplug the AC adaptor from the outlet before cleaning

Before cleaning the unit, turn it off and unplug the AC adaptor from the outlet (p. 10).



If there is a possibility of lightning strike, disconnect the AC adaptor from the outlet

Whenever you suspect the possibility of lightning in your area, disconnect the AC adaptor from the outlet.



Keep small items out of the reach of children

To prevent accidental ingestion of the parts listed below, always keep them out of the reach of small children.



- Included Parts
Wing bolts (p. 9)
- Removable Parts
Cap of the special connection cable

IMPORTANT NOTES

Power Supply

- Do not connect this unit to same electrical outlet that is being used by an electrical appliance that is controlled by an inverter or a motor (such as a refrigerator, washing machine, microwave oven, or air conditioner). Depending on the way in which the electrical appliance is used, power supply noise may cause this unit to malfunction or may produce audible noise. If it is not practical to use a separate electrical outlet, connect a power supply noise filter between this unit and the electrical outlet.
- The AC adaptor will begin to generate heat after long hours of consecutive use. This is normal, and is not a cause for concern.
- To prevent malfunction and equipment failure, always make sure to turn off the power on all your equipment before you make any connections.
- With the factory settings, this unit will automatically be switched off 30 minutes after you stop playing or operating the unit. If you don't want the unit to turn off automatically, change the "Auto Off" setting to "OFF" as described on p. 35.

Placement

- Using the unit near power amplifiers (or other equipment containing large power transformers) may induce hum. To alleviate the problem, change the orientation of this unit; or move it farther away from the source of interference.
- This device may interfere with radio and television reception. Do not use this device in the vicinity of such receivers.
- Noise may be produced if wireless communications devices, such as cell phones, are operated in the vicinity of this unit. Such noise could occur when receiving or initiating a call, or while conversing. Should you experience such problems, you should relocate such wireless devices so they are at a greater distance from this unit, or switch them off.
- Do not expose the unit to direct sunlight, place it near devices that radiate heat, leave it inside an enclosed vehicle, or otherwise subject it to temperature extremes. Excessive heat can deform or discolor the unit.
- When moved from one location to another where the temperature and/or humidity is very different, water droplets (condensation) may form inside the unit. Damage or malfunction may result if you attempt to use the unit in this condition. Therefore, before using the unit, you must allow it to stand for several hours, until the condensation has completely evaporated.
- Do not put anything that contains water on this unit. Also, avoid the use of insecticides, perfumes, alcohol, nail polish, spray cans, etc., near the unit. Swiftly wipe away any liquid that spills on the unit using a dry, soft cloth.

Maintenance

- For everyday cleaning wipe the unit with a soft, dry cloth or one that has been slightly dampened with water. To remove stubborn dirt, use a cloth impregnated with a mild, non-abrasive detergent. Afterwards, be sure to wipe the unit thoroughly with a soft, dry cloth.
- Never use benzene, thinners, alcohol or solvents of any kind, to avoid the possibility of discoloration and/or deformation.

Repairs and Data

- Please be aware that all data contained in the unit's memory may be lost when the unit is sent for repairs. Important data should always be backed up to USB flash drives, or written down on paper (when possible). During repairs, due care is taken to avoid the loss of data. However, in certain cases (such as when circuitry related to memory itself is out of order), we regret that it may not be possible to restore the data, and Roland assumes no liability concerning such loss of data.

Additional Precautions

- Please be aware that the contents of memory can be irretrievably lost as a result of a malfunction, or the improper operation of the unit. To protect yourself against the risk of losing important data, we recommend that you periodically save a backup copy of important data you have stored in the unit's memory to USB flash drives.
- Unfortunately, it may be impossible to restore the contents of data that was stored in the unit's memory or on USB flash drives once it has been lost. Roland Corporation assumes no liability concerning such loss of data.
- Use a reasonable amount of care when using the unit's buttons, sliders, or other controls; and when using its jacks and connectors. Rough handling can lead to malfunctions.
- Never strike or apply strong pressure to the display.
- When disconnecting all cables, grasp the connector itself—never pull on the cable. This way you will avoid causing shorts, or damage to the cable's internal elements.
- To avoid disturbing others nearby, try to keep the unit's volume at reasonable levels. You may prefer to use headphones, so you do not need to be concerned about those around you.
- Since sound vibrations can be transmitted through floors and walls to a greater degree than expected, take care not to allow such sound to become a nuisance to others nearby. Although the drum pads and pedals are designed so there is a minimal amount of extraneous sound produced when they're struck, rubber heads tend to produce louder sounds compared to mesh heads. You can effectively reduce much of the unwanted sound from the pads by switching to mesh heads.
- When you need to transport the unit, package it in the box (including padding) that it came in, if possible. Otherwise, you will need to use equivalent packaging materials.
- Some connection cables contain resistors. Do not use cables that incorporate resistors for connecting to this unit. The use of such cables can cause the sound level to be extremely low, or impossible to hear. For information on cable specifications, contact the manufacturer of the cable.
- The explanations in this manual include illustrations that depict what should typically be shown by the display. Note, however, that your unit may incorporate a newer, enhanced version of the system (e.g., includes newer sounds), so what you actually see in the display may not always match what appears in the manual.

Before Using External Memories

- Carefully insert the USB flash drives all the way in—until it is firmly in place.

Top panel

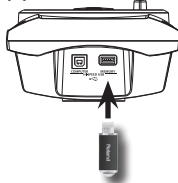

- Never touch the terminals of the USB flash drives. Also, avoid getting the terminals dirty.

- USB flash drives are constructed using precision components; handle the USB flash drives carefully, paying particular note to the following.
 - To prevent damage to the cards from static electricity, be sure to discharge any static electricity from your own body before handling the cards.
 - Do not touch or allow metal to come into contact with the contact portion of the cards.
 - Do not bend, drop, or subject cards to strong shock or vibration.
 - Do not keep cards in direct sunlight, in closed vehicles, or other such locations.
 - Do not allow cards to become wet.
 - Do not disassemble or modify the cards.

Handling CDs / DVDs

- Avoid touching or scratching the shiny underside (encoded surface) of the disc. Damaged or dirty CD discs may not be read properly. Keep your discs clean using a commercially available CD cleaner.

About Copyright

- It is forbidden by law to make an audio recording, video recording, copy or revision of a third party's copyrighted work (musical work, video work, broadcast, live performance, or other work), whether in whole or in part, and distribute, sell, lease, perform, or broadcast it without the permission of the copyright owner.
- Do not use this product for purposes that could infringe on a copyright held by a third party. We assume no responsibility whatsoever with regard to any infringements of third-party copyrights arising through your use of this product.
- The copyright of content in this product (the sound waveform data, style data, accompaniment patterns, phrase data, audio loops and image data) is reserved by Roland Corporation and/or Atelier Vision Corporation.
- Purchasers of this product are permitted to utilize said content for the creating, performing, recording and distributing original musical works.
- Purchasers of this product are NOT permitted to extract said content in original or modified form, for the purpose of distributing recorded medium of said content or making them available on a computer network.
- MMP (Moore Microprocessor Portfolio) refers to a patent portfolio concerned with microprocessor architecture, which was developed by Technology Properties Limited (TPL). Roland has licensed this technology from the TPL Group.
- MPEG Layer-3 audio compression technology is licensed from Fraunhofer IIS Corporation and THOMSON Multimedia Corporation.
- ASIO is a trademark of Steinberg Media Technologies GmbH.
- Roland, SuperNATURAL, and V-Drums are either registered trademarks or trademarks of Roland Corporation in the United States and/or other countries.
- Company names and product names appearing in this document are registered trademarks or trademarks of their respective owners.

Copyright © 2012 ROLAND CORPORATION
All rights reserved. No part of this publication may be reproduced in any form without the written permission of ROLAND CORPORATION.

Main Features

SuperNATURAL on V-Drums

Roland takes digital drums to a new height with the implementation of its exclusive SuperNATURAL concept. The best electronic drums in the world just got better.

Improved dynamics and sensitivity make every nuance of playing drums feel even more natural, no matter what your musical style might be.

What are SuperNATURAL Tones?

Taking advantage of Behavior Modeling Technology, SuperNATURAL is Roland's exclusive sound set that achieves a new level of realism and expression that were difficult to realize with previous sound generators.



Behavior Modeling Technology

Not only physical modeling of the instruments, Roland takes it a step further by modeling the instrument's distinctive behavior that responds to how the performer plays, resulting in true-to-life, expressive sounds in realtime.

Enjoy playing with the Internal songs & Song player

Internal songs (p. 26)

Realistic and powerful backing songs and loop phrases are built into the TD. These are perfect for practicing, or just the pure enjoyment of playing along.



Song player (p. 27)

You can play back audio files (WAV, MP3) directly from an inserted USB flash drive (optional). Also the Speed Control and A-B repeat functions allow you to take practicing with your favorite songs to a new level.



Advanced practice support

Coach mode (p. 31)

Roland's highly acclaimed Coach Mode provides a full set of exercises for self improvement. These include "Time Check," "Quiet Count," and "Warm Ups."



QUICK REC function (p. 14)

The QUICK REC function is another practice tool that allows you to record and playback your performance easily.

Using with your computer

USB audio and USB MIDI support (p. 47)

By connecting the TD to your computer with a single USB cable, you can transmit audio and MIDI data.

Perfect for using with the V-Drums Tutor, V-Drums Friend Jam and/or your own DAW software.



Contents

USING THE UNIT SAFELY	2
IMPORTANT NOTES	4
Main Features	5
Panel Descriptions	7
Front Panel.....	7
Side Panel (Connecting Your Equipment).....	8
Top Panel (Connecting Your Equipment)	9
Bottom Panel	9
Getting Ready to Play	10
Turning the Power On/Off	10
Playing the Drums	11
Drum Kits and Instruments	11
Selecting a Drum Kit.....	11
Cross-Stick Function.....	11
Performance Techniques	12
Using the Metronome	13
Starting the Metronome.....	13
Changing the Metronome Tempo and Volume	13
Recording Your Performance (QUICK REC).....	14
Quickly Editing an Instrument (QUICK EDIT) (TD-15 ONLY)	15
About the MENU Screens	16
Creating a Drum Kit	17
Changing the Instrument.....	17
Instrument Edit	18
Drum Kit Volume	18
Using the Effects (FX).....	19
Adjusting the Amount of Ambience for Each Pad (SEND).....	21
Turning the Multi-Effect On/Off for Each Pad (SWITCH) (TD-15 ONLY).....	21
Naming a Drum Kit.....	22
Changing the MIDI Note Number of Each Pad	22
Copying and Pasting a Drum Kit or Pad	23
Saving a Drum Kit to a USB Flash Drive.....	24
Saving a Drum Kit	24
Loading a Drum Kit from a USB Flash Drive into the TD.....	25
Restoring a Drum Kit to the Factory Settings	25
Performing Along with a Song	26
Selecting a Song	27
Playing the Song	27
Changing the Song Settings.....	28
Selecting a Folder	28
Repeatedly Playing a Specified Region (A-B Repeat).....	29
Viewing Song Information.....	29
Play Along with a Song and Record Your Performance (QUICK REC)	30
Practicing in Coach Mode	31
Selecting a Practice Menu	31
Settings for the Entire TD (SYSTEM)	34
Overall Settings for the TD (Options)	35
Metronome Setup (Metronome).....	36
Using a Pad as a Switch (Pad Control) (TD-15 ONLY)	36
MIDI-Related Settings (MIDI).....	37
Using USB Flash Drive (USB Memory)	38
Saving Data to a USB Flash Drive (Save Backup).....	38
Loading Data from a USB Flash Drive Back into the TD (Load Backup)	39
Deleting Data from a USB Flash Drive (Delete Data).....	39
Viewing Information About the USB Flash Drive (Information).....	40
Formatting a USB Flash Drive (Format)	40
Optimizing the Pad Settings (Pad Settings).....	41
Specifying the Type of Pad [F1] (TYPE).....	41
Setting the Pad Sensitivity [F2] (BASIC).....	42
Advanced Settings for the Trigger Parameters [F3] (ADVNC D)	43
Viewing Information About the TD (Information).....	46
Restoring the Factory Settings (Factory Reset).....	46
Connecting to a Computer or Video Device	47
Connecting to Your Computer via USB	47
Installing the USB Driver.....	47
Connecting the TD to the Computer	47
Controlling Images.....	47
Troubleshooting	48
Error Messages	49
Main Specifications	50
Index	51

Panel Descriptions

Front Panel

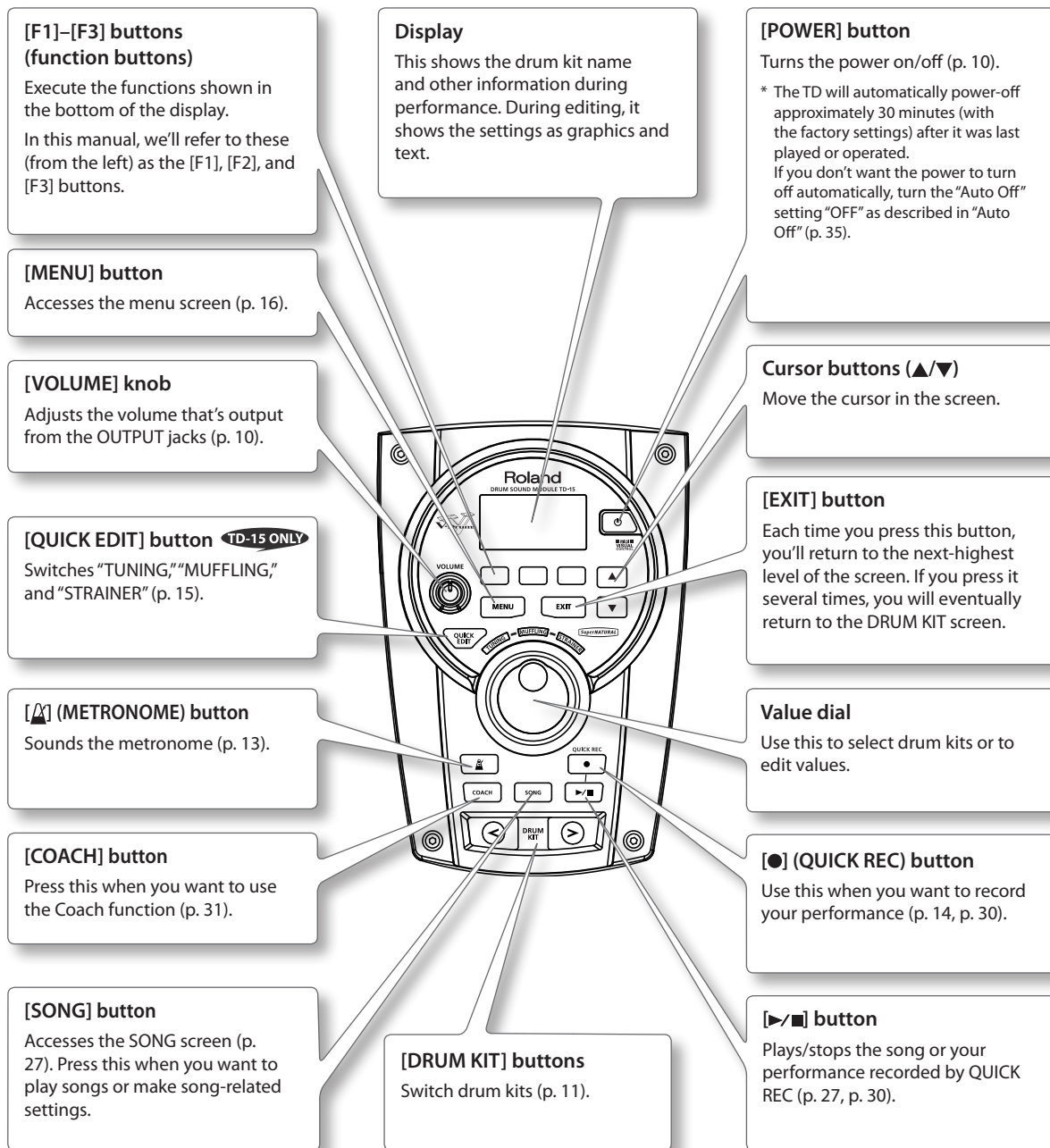

* The illustration shows the TD-15.

How to read this manual

- This owner's manual applies to both the TD-15 and the TD-11. These two devices will be collectively referred to as the "TD."
- Functions found only on the TD-15 are indicated by the TD-15 ONLY icon.
- Buttons on the panel are enclosed by square brackets []; for example, the [SETUP] button.
- Buttons corresponding to function buttons shown in the display are referred to as (for example) the [F3] (XSTICK) button.

Side Panel (Connecting Your Equipment)

DC IN jack

Connect the included AC adaptor here.

Place the AC adaptor so the side with the indicator (see illustration) faces upwards and the side with textual information faces downwards. The indicator will light when you plug the AC adaptor into an AC outlet.



OUTPUT jacks (L/MONO, R)

For connecting to your audio system or amp. All sounds from the TD are output here.

For outputting sounds in MONO, connect the cable to the L/MONO jack.



MIDI OUT connector

Use this when you want to trigger an external MIDI sound module, sampler, etc., from the TD (p. 37).

[VOLUME] knob

TD-15 ONLY

Adjusts the volume of the headphones.

PHONES jack

Connect stereo headphones here. Sound will still be output from the OUTPUT jacks even if headphones are connected.



MIX IN jack

By connecting your audio player or other audio source via a stereo mini-plug, you can enjoy playing the drum along with your favorite songs.

* The volume will be determined by connected device.



TRIGGER IN jacks (CRASH2, AUX **TD-15 ONLY**)

These allow you to connect additional pads.

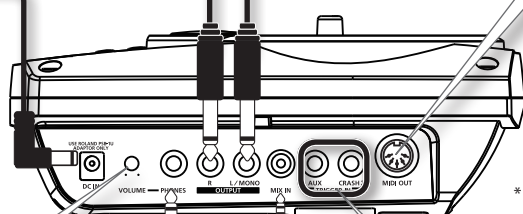

* The illustration shows the TD-15.

NOTE

- To prevent malfunction and equipment failure, always turn down the volume, and turn off all the units before making any connections.
- When connection cables with resistors are used, the volume level of equipment connected to the MIX IN jack may be low. If this happens, use connection cables that do not contain resistors.

Top Panel (Connecting Your Equipment)

COMPUTER port

Use a USB cable to connect the TD to your computer (p. 47). MIDI data and audio data can be sent via USB to and from your DAW software.

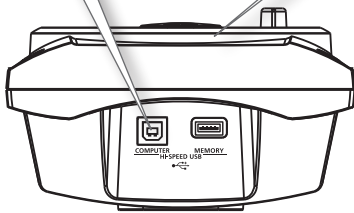

MEMORY port

You can connect your USB flash drive (separately sold) here, and play back audio files from it (p. 27) or save TD settings on it (p. 38).



MEMORY
USB



NOTE

- Use USB flash drive sold by Roland. We cannot guarantee operation if other products are used.
- Never insert or remove a USB flash drive while this unit is turned on. Doing so may corrupt the unit's data or the data on the USB flash drive.
- Carefully insert the USB flash drive all the way in-until it is firmly in place.

Bottom Panel

TRIGGER INPUT connector

Connect the included dedicated cable to this connector, and use it to connect the pads and pedals.

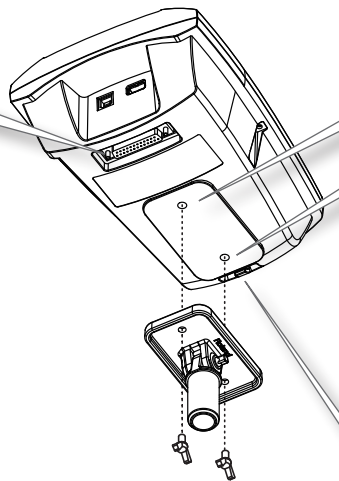

Sound module mounting plate attachment holes

Attach the included sound module mounting plate here to attach the TD to your drum stand.

Use the included wing bolts to attach the plate as shown in the illustration.

- * Use only the included wing bolts. Using any other bolts will cause malfunctions.
- * The TD must be attached to the sound module mounting plate when in use.

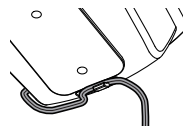

To prevent the inadvertent disruption of power to your unit (should the plug be pulled out accidentally), and to avoid applying undue stress to the DC IN jack, anchor the power cord using the cord hook, as shown in the illustration.

NOTE

When turning the unit upside down, be sure to handle the unit with care so as to prevent damage to the buttons, knobs, etc.

Getting Ready to Play

Turning the Power On/Off

Turning the power on

- * Once everything is properly connected (p. 8), be sure to follow the procedure below to turn on their power. If you turn on equipment in the wrong order, you risk causing malfunction or equipment failure.
- * Before turning the unit on/off, always be sure to turn the volume down. Even with the volume turned down, you might hear some sound when switching the unit on/off. However, this is normal and does not indicate a malfunction.

1. Turn the [VOLUME] knob all the way to the left to minimize the volume.



TD-15 ONLY

If you're using headphones, you should also minimize the [VOLUME] knob located on the side panel.

2. Minimize the volume of the connected amp or audio system.
3. Press the [POWER] button.



* This unit is equipped with a protection circuit. A brief interval (a few seconds) after turning the unit on is required before it will operate normally.

4. Power-on the amp or audio system that's connected to the TD.
5. While striking the pads to hear the sound, adjust the volume by gradually turning the [VOLUME] knob toward the right.

Also adjust the volume appropriately on the connected amp or audio system.

TD-15 ONLY

If you're using headphones, you should also minimize the [VOLUME] knob located on the side panel.

Turning the power off

NOTE

Settings you've edited on the TD itself will be saved when you turn off the power. Be sure to turn off the power by pressing the [POWER] button.

1. Minimize the volume of the TD and of the external equipment connected to the TD.
2. Power-off the external equipment.
3. Hold down the [POWER] button until the screen indicates "See you!"

If you don't want the power to turn off automatically, change the "Auto Off" setting to "OFF!"

The TD will automatically power-off approximately 30 minutes (with the factory settings) after it was last played or operated.

If you don't want the power to turn off automatically, turn the "Auto Off" setting "OFF" as described on p. 35.

Playing the Drums

Drum Kits and Instruments

On the TD, the sound you hear when you strike each pad is called an “instrument.” A “drum kit” is a set of sounds (instruments) assigned to the pads.



The illustration below shows the structure of a drum kit.

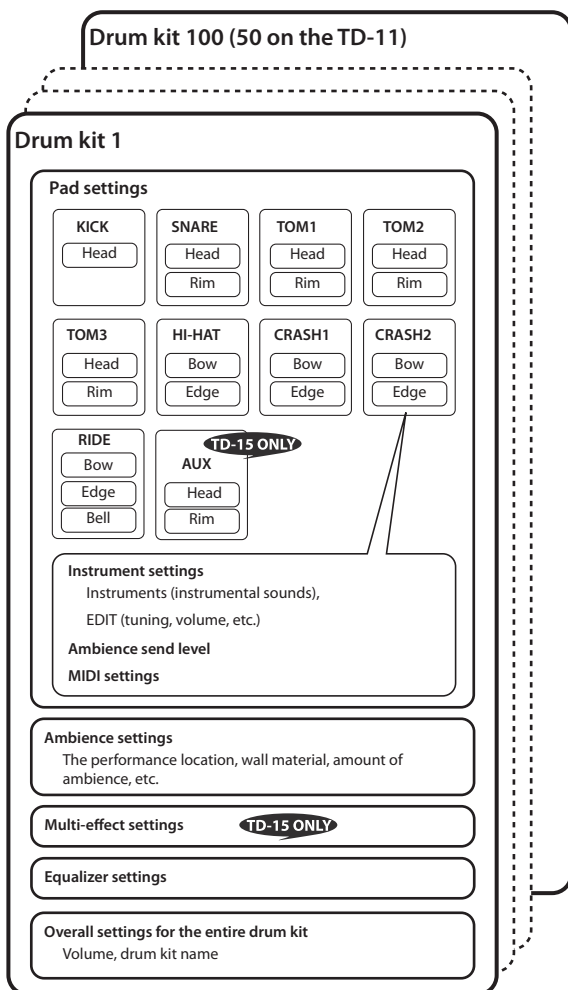

What do Head and Rim mean?

On the TD, settings for a pad’s head and rim (for a cymbal, the bow and edge) can be made separately.

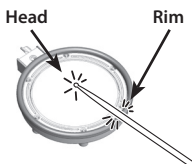

Selecting a Drum Kit

1. Use the [DRUM KIT] buttons to select a drum kit.

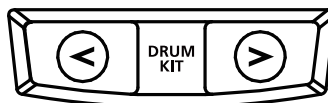

The DRUM KIT screen will appear.

No matter what screen is in use, by pressing the [DRUM KIT] button, you will return to the DRUM KIT screen.

Selecting a drum kit from the list

In the DRUM KIT screen, you can turn the value dial to access the KIT LIST and select a drum kit from the list.

About the DRUM KIT screen

This is the TD’s main screen; it will appear when you press a [DRUM KIT] button.

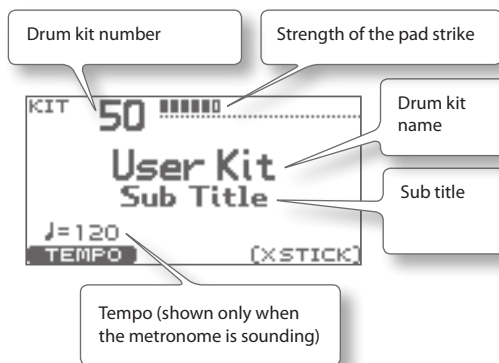

Cross-Stick Function

Pressing the [F3] (XSTICK) button enables or disables the ability to play the cross-stick sound (p. 12) on the rim of the snare pad.



* The [F3] (XSTICK) button is shown only if cross-stick is enabled.

Performance Techniques

Pads (such as PDX-100/PDX-8/PDX-6)

Head shot

Hit only the head of the pad.

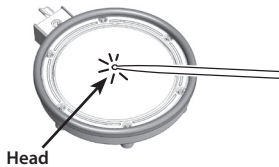

Rim shot

Strike the head and the rim of the pad simultaneously. A sound (rim sound) different than the head shot will be heard.

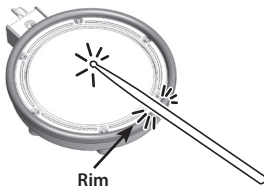

Cross stick

When XSTICK (p. 11) is on:

Only strike the rim of the pad.

Depending on the sound assigned to the rim you can play rim shots and/or cross stick sounds.

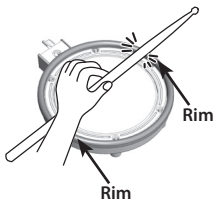

- * This is supported only for the snare pad.
- * To play the cross stick, be sure that you only strike the rim of the pad. Place your hand on the head gently, otherwise this may prevent the cross stick function from working properly.

Cymbals (such as CY-13R/CY-8)

Bow shot

The most common method, playing the middle area of the cymbal.

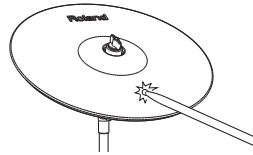

Edge shot

Use the shoulder of the stick to hit the edge sensor of the cymbal pad (as shown in the figure).

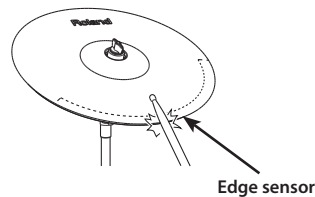

Bell shot (CY-15R, CY-13R)

Strike the bell area.

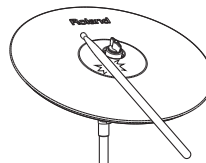

- * Strike the bell somewhat strongly with the shoulder of the stick.

Choking a cymbal

Choking (pinching) the cymbal's edge with the hand immediately after hitting the cymbal will mute or choke the sound, just like with a real cymbal. The Choke function only works when you grasp in the area (where the edge sensor is) as shown in the figure. If you do otherwise, it will not work.

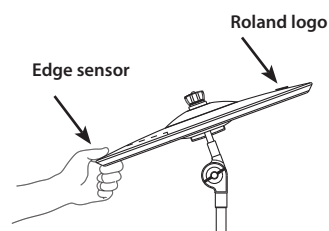

Hi-Hat (CY-5/VH-11)

Open/Closed

The hi-hat sound will change smoothly between open and closed depending on pressure applied to the hi-hat control pedal or a hi-hat stand.

Foot closed and foot splash sounds are possible.

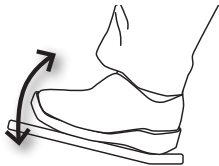

Bow shot

Hit the striking surface of the hi-hat.

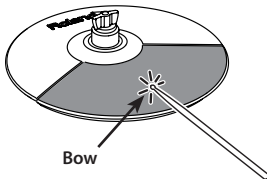

Edge shot

Use the shoulder of the stick to hit the edge of the hi-hat pad.

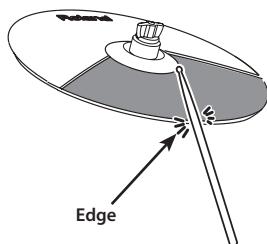

Using the Metronome

Practicing with the metronome is the best way to develop accurate timing.

Starting the Metronome

1. Press the **[M]** button.

The metronome will start playing, and the button will blink in time with the tempo.

MEMO

You can change the way in which the metronome sounds (p. 36).

Changing the Metronome Tempo and Volume

1. In the DRUM KIT screen (p. 11), press the **[F1] (TEMPO)** button.

The METRONOME screen will appear.

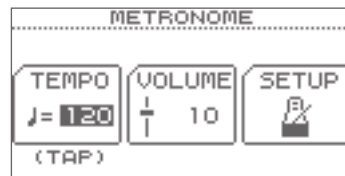

2. Use the **[F1]–[F3]** buttons to select the item that you want to edit, and use the value dial to edit the setting.

Button	Value	Description
[F1] (TEMPO)	20–260	Use the value dial to set the tempo. * You can set the tempo by pressing the [F1] (TEMPO) button three or more times in succession at the desired interval.
[F2] (VOLUME)	0–10	Use the value dial to set the volume.
[F3] (SETUP)		Accesses the METRONOME SETUP screen (p. 36).

Recording Your Performance (QUICK REC)

The TD lets you easily record and play back your own performance (QUICK REC).

This is a convenient way to repeatedly record yourself practicing and then play back to check your performance.

* Before you continue, select the drum kit that you want to use for practicing (recording).

MEMO

You can also record your playing along with a song. For details, refer to p. 30.

1. In the DRUM KIT screen (p. 11), press the [Q] (QUICK REC) button.

The [Q] (QUICK REC) button will light, and the QUICK REC screen will appear.



MEMO

If you want to hear the metronome while you record, press the [M] button to turn on the metronome. Use the value dial to set the tempo.

2. To start recording, strike a pad or press the [R] button.

* When recording starts, the previous recording will be completely erased.

3. Press the [R] button to stop recording.

4. Press the [R] button once again.

The recorded performance will play back.



You can press the [F2] (REPEAT) button to make the performance play back repeatedly.

5. Press the [R] button to stop playback.

NOTE

Whenever you turn on the power, the TD is prepared for the playback of its demo patterns. After you've made a recording, if you turn off the power, the data for the recording will be erased. Then, the next time the power is switched on, the demo patterns will once again be loaded in from internal memory.

Where the recorded data is exported

When a USB flash drive is connected, your recorded data is automatically exported to the USB flash drive. Only the five most recent recorded performances will be exported as SMF data.



MEMO

SMF (Standard MIDI File) is a standard file format that allows performance data to be exchanged between various musical applications.

The recorded data is saved in the following folder of the USB flash drive.

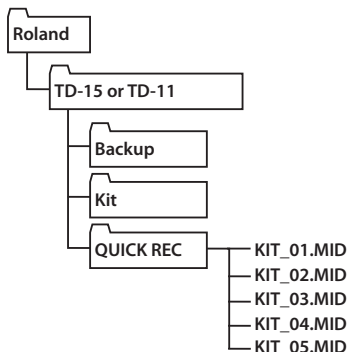

Quickly Editing an Instrument (QUICK EDIT) TD-15 ONLY

The TD-15's QUICK EDIT function lets you make quick and easy adjustments to the sound of each instrument.

1. Before you continue, select the drum kit that contains the instrument you want to edit.

2. In the DRUM KIT screen (p. 11), press the [QUICK EDIT] button.

Each time you press the button, you'll cycle between "Tuning," "Muffling," and "Strainer," and then return to the DRUM KIT screen.

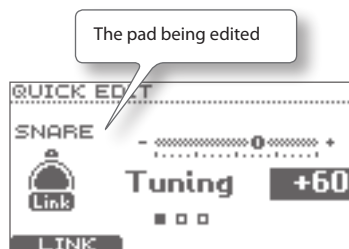

3. Strike the pad whose instrument you want to edit.

The screen will show the edit screen for the pad you struck.

4. Use the value dial to edit the value.

Parameter	Value	Description
Tuning	-240~+240	Negative (-) settings will lower the pitch, and positive (+) settings will raise the pitch.
Muffling	0-50	Larger values will reduce the resonance and emphasize the attack.
Strainer	1-10	Strainer (snare) tension. Higher values make the tension tighter.
Snare Buzz	0-10	Resonance of the snare. Higher values increase the resonance.

* The editable parameters will differ depending on the instrument group.

5. Press the [EXIT] button to return to the DRUM KIT screen.

About the MENU Screens

There are eight menu screens that allow you to edit the drum kit.

In the DRUM KIT screen, press the [MENU] button to access the KIT MENU screen, from which you can jump to each edit screen.

INST
Change instruments, or adjust the overall volume of the drum kit (p. 17).

FX
Apply an effect to the entire drum kit (p. 19).

Menu	Description
Ambience	Ambience settings
TD-15 ONLY Multi-FX	Multi-effect settings
EQ	EQ settings

NAME
Assign a name to the drum kit (p. 22)

MIDI
Change the MIDI note number of each pad (p. 22).

COPY/PASTE
Copy and paste drum kits or pads (p. 23).

SAVE/LOAD
Save a drum kit to your USB flash drive, or load a previously-saved drum kit from the USB flash drive back into the TD (p. 24).

1 KIT RESTORE
This lets you return the currently selected drum kit to the factory settings (p. 25).

SYSTEM
Here you can edit settings that apply to the entire TD (p. 34).

Menu	Description	Page
Options	Settings for display contrast and power (Auto Off)	p. 35
Metronome	Metronome settings	p. 36
TD-15 ONLY Pad Control	Settings for the pads connected to the TRIGGER IN AUX jacks	p. 36
MIDI	MIDI-related settings	p. 37
USB Memory	Use a USB flash drive	p. 38
Wireless	Refer to the separate document "About the Wireless LAN Function."	—
Pad Settings	Pad settings	p. 41
Information	View information about the TD itself	p. 46
Factory Reset	Restore the factory settings	p. 46

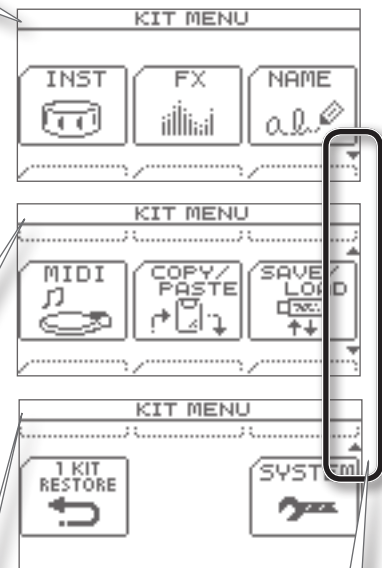

Use the cursor buttons (▲/▼) to scroll the screen.

Creating a Drum Kit

You can edit the individual sounds in each kit to customize them for your musical style.

Changing the Instrument

On the TD, each instrumental sound, such as the kick drum or snare drum within the drum kit, is called an “instrument (INST).”

1. In the DRUM KIT screen (p. 11), press the [MENU] button.

The KIT MENU screen will appear.



2. Press the [F1] (INST) button.

The INST screen will appear.

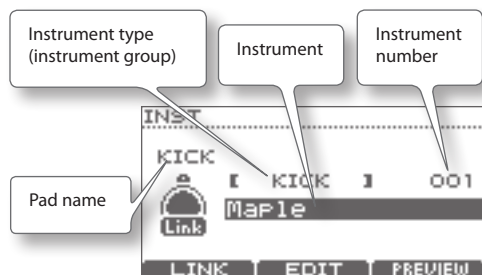

3. Strike the pad whose instrument you want to change.

The edit screen for the pad you struck will appear.

MEMO

Alternatively, you can use the cursor buttons (▲/▼) to move the cursor to the pad name, and then use the value dial to select a pad.

4. Use the cursor buttons (▲/▼) to move the cursor to the desired instrument group or instrument.
5. Use the value dial to change the instrument group or instrument.
6. Press the [EXIT] button several times to return to the DRUM KIT screen.

Individual head and rim settings (Link)

For some pads, you can assign different instruments to the head and rim (for a cymbal, to the bow and the bell). To enable this, turn Link off.

1. In the INST screen, press the [F1] (LINK) button.

Each time you press the button, LINK will turn on/off.

Value	Description
ON	For SNARE, TOM1–3, HIHAT, CRASH1–2, RIDE, and AUX (TD-15 only), the head and rim settings (instrument, tuning, muffling, pad volume, pan) will change in tandem.
OFF	For SNARE, TOM1–3, HIHAT, CRASH1–2, RIDE, and AUX (TD-15 only), the head and rim settings can be changed independently.

Previewing (auditioning) an instrument

When the INST screen is displayed, you can strike the pad or press the [F3] (PREVIEW) button to preview the selected instrument.

Creating a Drum Kit

Instrument Edit

1. In the DRUM KIT screen (p. 11), press the [MENU] button.

The KIT MENU screen will appear.

2. Press the [F1] (INST) button.

The INST screen will appear.

3. Strike the pad whose instrument settings you want to edit.

The edit screen for the pad you struck will appear.

4. Press the [F2] (EDIT) button.

The INST EDIT screen will appear.

The "+" indication is shown if the head and rim are set to different values even though LINK is on.



5. Use the cursor buttons (▲/▼) to select a parameter.

6. Use the value dial to edit the value of that parameter.

For details on the parameters that can be edited, refer to "INST EDIT parameter list" below.

7. Press the [EXIT] button several times to return to the DRUM KIT screen.

INST EDIT parameter list

* The editable parameters will differ depending on the instrument group.

Parameter	Value	Description
Tuning	-240~+240	Negative (-) values will lower the pitch, and positive (+) values will raise the pitch.
Muffling	0-50	Larger values will decrease the resonance, emphasizing the attack of the sound.
Snare Buzz	0-10	Higher values will make the snare resonance louder.
Strainer	1-10	Higher values make the strainer (snare) tension tighter.

Parameter	Value	Description	
Fixed HH	NORMAL, FIXED1-4	NORMAL	The openness of the hi-hat can be changed by the pedal.
		FIXED	The openness of the hi-hat will be fixed.
Tone Color	-50~+50	Adjusts the brightness of the tone. Positive (+) values make the tone brighter; negative (-) values make the tone darker.	
Volume	0-100	Specifies the volume.	
Pan	L15-CENTER-R15	Specifies the pan (stereo position).	

Drum Kit Volume

1. In the INST EDIT screen, press the [F3] (KIT VOL) button.

The KIT VOLUME screen will appear.



2. Use the cursor buttons (▲/▼) to select a parameter.

3. Use the value dial to edit the value of that parameter.

Parameter	Value	Description
Kit Volume	0-100	Overall drum kit volume
Pedal HH Volume	0-100	Pedal hi-hat volume
Xstick Volume	0-100	Cross-stick volume

4. Press the [EXIT] button several times to return to the DRUM KIT screen.

Using the Effects (FX)

How each effect works

AMBIENCE

This produces an ambience (room reverberation) that's ideal for drum sounds. You can adjust the room ambience (the type and size of the room) and the reverb (reverberation).

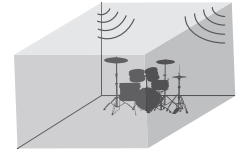

MULTI-FX **TD-15 ONLY**

This is a powerful multi-effect that can be used to transform your sound. You can use it to distort the sound, or give it depth and spaciousness.

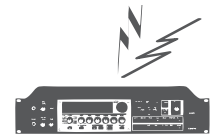

EQ

This is a four-band (low, two mid bands, high) equalizer. Use it to adjust the tonal character.

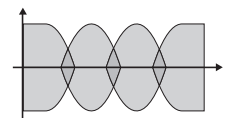

Basic procedure

1. In the DRUM KIT screen (p. 11), press the [MENU] button.

The KIT MENU screen will appear.

2. Press the [F2] (FX) button.

The FX screen will appear.

3. Press a function button to select the item that you want to edit.

[F1] (AMBIENCE)	Ambience
[F2] (MULTI-FX)	Multi-effect TD-15 ONLY
[F3] (EQ)	Equalizer

* The MULTI-FX function is provided only on the TD-15.

The edit screen for the selected effect will appear.

Use the cursor buttons (▲/▼) to select a parameter.

Use the value dial to edit the value.

Use the [F1]–[F3] buttons to switch tabs (screens).

4. Press the [EXIT] button several times to return to the DRUM KIT screen.

Creating a Drum Kit

FX parameter list

Parameter	Value	Description
[F1] (AMBIENCE)		
Type	10 types	Type of ambience
Character	1–7	Character of the ambience sound
Size	TINY, SMALL, MEDIUM, LARGE, HUGE	Size of the room
Wall Type	CURTAIN, CLOTH, WOOD, PLASTER, CONCRETE, GLASS	Material of the walls
Shape	0–100	Width of the room
Level	0–100	Overall amount of ambience
Ambience Send	0–100	Amount sent from each pad to the ambience
TD-15 ONLY MFX to Ambi Send	0–100	Amount sent from the multi-effect to the ambience
[F2] (MULTI-FX) TD-15 ONLY		
Type	10 types	Type of multi-effect For details on multi-effect's parameters, download "Data List" (PDF file) from "TD-15" in the "Owner's Manuals" list on the Roland website (http://www.roland.com/support/en/).
[F3] (EQ)		
High Freq	1 kHz–8 kHz	Frequency of the high region
High Gain	-12 dB–+12 dB	Amount of boost/cut for the high region
Low Freq	20 Hz–1 kHz	Frequency of the low region
Low Gain	-12 dB–+12 dB	Amount of boost/cut for the low region
Mid1 Freq	20 Hz–8 kHz	Frequency of the mid-1 region
Mid1 Q	0.5, 1.0, 2.0, 4.0, 8.0	Width of the mid-1 region Larger values make the width more narrow.
Mid1 Gain	-12 dB–+12 dB	Amount of boost/cut for the mid-1 region
Mid2 Freq	20 Hz–8 kHz	Frequency of the mid-2 region
Mid2 Q	0.5, 1.0, 2.0, 4.0, 8.0	Width of the mid-2 region Larger values make the width more narrow.
Mid2 Gain	-12 dB–+12 dB	Amount of boost/cut for the mid-2 region

Adjusting the Amount of Ambience for Each Pad (SEND)

You can adjust the amount of ambience (the send level) for each pad.

1. Access the AMBIENCE screen as described in steps 1–3 of the basic procedure (p. 19).
2. Press the [F3] (SEND) button.
The AMBIENCE SEND screen will appear.
3. Press the [F1] (LINK) button to turn Link on/off.
4. Select a pad, either by striking that pad or by pressing the [F2] (◀) or [F3] (▶) buttons.
The cursor will move to the pad you selected.

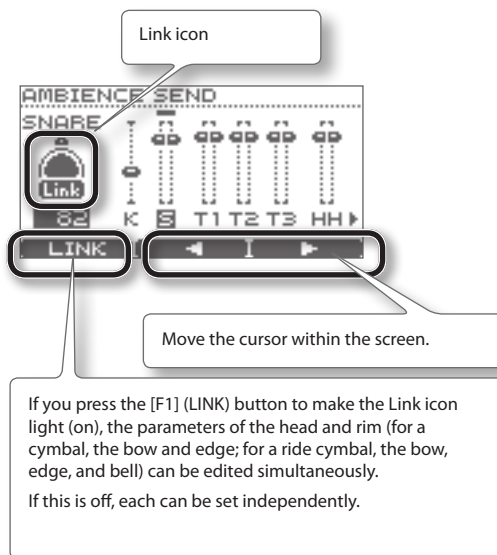

Indication in the screen	Pad
K	Kick
S	Snare
T1–T3	Tom 1–3
HH	Hi-hat
C1, C2	Crash 1, 2
RD	Ride
TD-15 ONLY AUX	Pad connected to the AUX jack
TD-15 ONLY MFX	Ambience send amount from MFX

5. Use the value dial to specify the amount of ambience (send level).

Value	0–100
-------	-------

6. Press the [EXIT] button several times to return to the DRUM KIT screen.

Turning the Multi-Effect On/Off for Each Pad (SWITCH) **TD-15 ONLY**

You can specify whether the multi-effect will be applied to each pad (on) or not applied (off).

1. Access the MULTI-FX screen as described in steps 1–3 of the basic procedure (p. 19).
2. Press the [F3] (SWITCH) button.
The MULTI-FX SWITCH screen will appear.
3. Press the [F1] (LINK) button to turn Link on/off.
4. Select a pad, either by striking that pad or by pressing the [F2] (◀) or [F3] (▶) buttons.
The cursor will move to the pad you selected.
For details on the screen, refer to the explanation of the AMBIENCE SEND screen (p. 21).
5. Use the value dial to turn the effect on/off.
6. Press the [EXIT] button several times to return to the DRUM KIT screen.

Naming a Drum Kit

You can assign a name of up to 12 characters to each drum kit.

You can also assign a sub title of up to 14 characters below the kit to indicate the musical style or the date on which you created the kit.

1. In the DRUM KIT screen (p. 11), press the [MENU] button.

The KIT MENU screen will appear.

2. Press the [F3] (NAME) button.

The KIT NAME screen will appear.



3. Press the [F1] (←) or [F2] (→) button to move the cursor to the character that you want to change.

4. Use the value dial to change the character.

You can delete or insert a character by holding down the [F3] (DEL/INS) button and pressing the [F1] or [F2] button.

Button	Description
[F3]+[F1] (DEL)	Deletes the character at the cursor position; subsequent characters will move one place to the left.
[F3]+[F2] (INS)	Inserts a space at the cursor position; subsequent characters will move one place to the right.

5. Press the [EXIT] button several times to return to the DRUM KIT screen.

Changing the MIDI Note Number of Each Pad

Here's how to change the MIDI note number that is transmitted and received by each pad.

MEMO

The settings in this screen will be ignored if the SYSTEM menu setting "Std MIDI Setup Lock" is "ON" (p. 37).

1. In the DRUM KIT screen (p. 11), press the [MENU] button.

The KIT MENU screen will appear.

2. Press the cursor buttons (▲/▼) or the [MENU] button to scroll the screen, and press the [F1] (MIDI) button.

The MIDI NOTE NUMBER screen will appear.

3. Strike the pad whose settings you want to change.

The edit screen of the pad you struck will appear.

MEMO

You can also select a pad by using the cursor buttons (▲/▼).

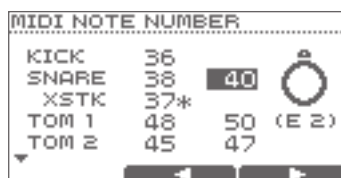

Press the [F2] (◀) or [F3] (▶) buttons to select the head/rim (bow/edge/bell) of each pad.

4. Use the value dial to edit the value.

Value	0-127, OFF
-------	------------

* If the same note number as another pad is selected, an "*" is shown at the right of the note number.

5. Press the [EXIT] button several times to return to the DRUM KIT screen.

Copying and Pasting a Drum Kit or Pad

You can copy the settings of a drum kit or pad, and paste them to another kit or pad.

NOTE

When you execute the paste operation, the contents of the paste-destination will be erased. Use this operation with caution.

- Press the [F1] (SEL) button to specify whether you want to copy a drum kit or a pad.

When copying a drum kit

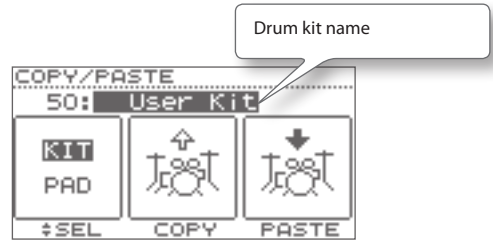

When copying a pad

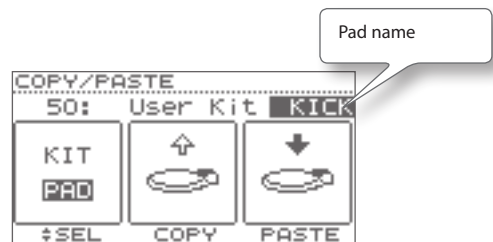

The contents that are copied

For a drum kit

Copied settings	Remarks
Settings for the entire drum kit	Volume, drum kit name
Ambience settings	On/off, performance location, wall material, amount, etc.
Equalizer settings	High/mid/low adjustment
TD-15 ONLY	—
MFX settings	—
Settings for each pad	Instrument, INST EDIT parameters, MIDI note numbers

For a pad

Copied settings	Remarks
Instrument settings	Instrument, INST EDIT parameters

* Effect settings and MIDI note numbers are not copied.

- Use the value dial to select the drum kit or pad that you want to copy.

MEMO

- You can also strike a pad to audition the drum kit or pad that you're copying.
- When copying and pasting a pad, you can also switch the drum kit. Use the cursor buttons (▲/▼) to move the cursor to the drum kit name, and use the value dial to change drum kits.

- Press the [F2] (COPY) button.

The contents of the drum kit or pad will be copied to the clipboard.

- Use the value dial to select the paste-destination drum kit or pad.

MEMO

The instrument settings of both the head and rim will be copied at the same time.

- In the DRUM KIT screen (p. 11), press the [MENU] button.

The KIT MENU screen will appear.

- Press the cursor buttons (▲/▼) or the [MENU] button to scroll the screen, and press the [F2] (COPY/PASTE) button.

The COPY/PASTE screen will appear.

Creating a Drum Kit

7. Press the [F3] (PASTE) button.

If you're pasting a pad, the paste operation will occur at this point.

If you're pasting a drum kit, a confirmation screen will appear.



* If you decide to cancel, press [F1] (CANCEL).

8. Press the [F3] (OK) button.

The contents of the clipboard will be overwritten onto the paste-destination.

9. Press the [EXIT] button several times to return to the DRUM KIT screen.

Saving a Drum Kit to a USB Flash Drive

Here's how you can save a drum kit to your USB flash drive.

Saving a Drum Kit

1. Connect your USB flash drive (p. 9).
2. Make sure that the drum kit you want to save is selected.
3. In the DRUM KIT screen (p. 11), press the [MENU] button.
The KIT MENU screen will appear.
4. Press the cursor buttons (▲/▼) or the [MENU] button to scroll the screen, and press the [F3] (SAVE/LOAD) button.
The 1 KIT SAVE/LOAD screen will appear.

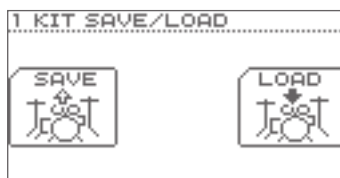

5. Press the [F1] (SAVE) button.

The 1 KIT SAVE screen will appear.

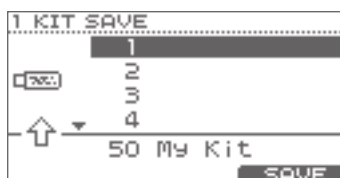

6. Use the cursor buttons (▲/▼) or the value dial to specify the save-destination.

7. Press the [F3] (SAVE) button.

* If data already exists at the save-destination, a confirmation screen will appear.

Press the [F3] (OK) button to execute the save operation. If you decide to cancel, press the [F1] (CANCEL) button.

The drum kit you selected in step 2 will be saved to your USB flash drive.

When the data has been saved, the screen will indicate "Completed" and return to the DRUM KIT screen.

Loading a Drum Kit from a USB Flash Drive into the TD

1. Connect your USB flash drive (p. 9).
2. Make sure that the loading-destination drum kit is selected.
3. In the DRUM KIT screen (p. 11), press the [MENU] button.

The KIT MENU screen will appear.

4. Press the cursor buttons (▲/▼) or the [MENU] button to scroll the screen, and press the [F3] (SAVE/LOAD) button.

The 1 KIT SAVE/LOAD screen will appear.

5. Press the [F3] (LOAD) button.

The 1 KIT LOAD screen will appear.

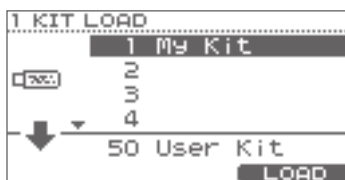

6. Use the cursor buttons (▲/▼) or the value dial to select the drum kit that you want to load.

7. Press the [F3] (LOAD) button.

A confirmation screen will appear.



* If you decide to cancel, press the [F1] (CANCEL) button.

8. Press the [F3] (OK) button.

The drum kit from the USB flash drive will be overwritten onto the drum kit you selected in step 2.

When loading is finished, the screen will indicate "Completed" and return to the DRUM KIT screen.

Restoring a Drum Kit to the Factory Settings

Here's how the currently selected drum kit can be restored to its factory-set state.

An accidentally-overwritten drum kit can also be restored by this operation.

NOTE

The currently selected drum kit will be overwritten.

1. Make sure that you've selected the drum kit that you want to restore to its original state.

2. In the DRUM KIT screen (p. 11), press the [MENU] button.

The KIT MENU screen will appear.

3. Press the cursor buttons (▲/▼) or the [MENU] button to scroll the screen, and press the [F1] (1 KIT RESTORE) button.

The 1 KIT RESTORE screen will appear, and a list of the factory-set drum kits will be shown.



4. Use the cursor buttons (▲/▼) or the value dial to select the desired drum kit.

5. Press the [F3] (RESTORE) button.

A confirmation screen will appear.



* If you decide to cancel, press the [F1] (CANCEL) button.

6. Press the [F3] (OK) button.

When the data has been restored, the screen will indicate "Completed" and return to the DRUM KIT screen.

Performing Along with a Song

The TD contains built-in-songs and phrases covering a variety of styles selected for enhancing your practice time. You can play the drums while listening to one of these songs.

If a USB flash drive is connected, you can play the drums while listening to one of your favorite songs from the USB flash drive.

Song structure

A song contains MP3 or WAV audio tracks and drum tracks (MIDI data) containing a drum performance.

For some internal songs there is a guide drum part on its drum track, which you can mute in order to play along with the song.

You can also use the QUICK REC function to record your performance with the songs.

After doing so, when playing them back you can mute the drum part you have recorded.



This button is shown if the song contains drum data.

* The song's performance data is not transmitted from the MIDI OUT connector.

Audio files that can be played by the TD

You can play back audio files of the following formats from a USB flash drive.

MP3	
Sampling rate	44.1 kHz
Bit rates	64 kbps–320 kbps
WAV	
Sampling rate	44.1 kHz
Bit depth	8, 16, 24-bit

When transferring files from your computer to a USB flash drive

Audio files can be played back not only from the root level (top level) of the USB flash drive, but also from within a folder.

For details on how to select a folder, refer to "Selecting a Folder" (p. 28).

- * The file name will be the song name.
- * Use only single-byte alphanumeric characters in the file name.
- * File names containing more than 14 characters or containing double-byte characters will not be displayed correctly.
- * You can put up to 100 song files in a single folder.
- * Make sure that no single file is larger than 2 GB.

Selecting a Song

If you want to select a song from a USB flash drive, you must first connect the USB flash drive to the TD (p. 9).

NOTE

If you have recorded your drum performance along with a song, this data will be lost when changing songs.

1. Press the [SONG] button.

The button will light, and the SONG screen will appear.



Use the cursor buttons (▲/▼) to switch between internal songs (Internal) and songs (or folder names) on the USB flash drive.

MEMO

For details on how to select a folder, refer to "Selecting a Folder" (p. 28).

2. Use the value dial or the [F1] (◀◀)/[F2] (▶▶) buttons to select a song.

About the SONG screen

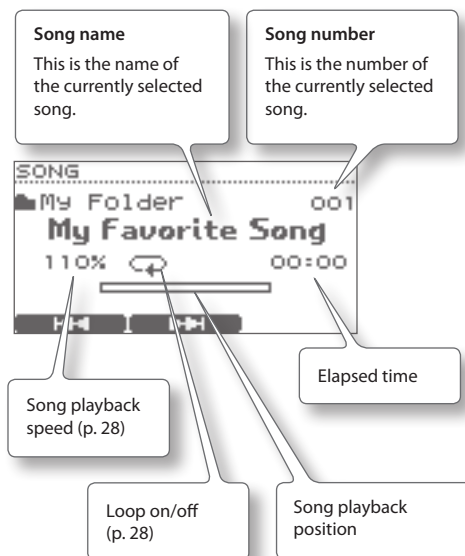

Playing the Song

1. Use the following buttons to play back the song.

Button	Function
[▶/■]	Play/stop song
[F1] (◀◀)	Selects the previous song. Hold down to rewind the song.
[F2] (▶▶)	Selects the next song. Hold down to fast-forward the song.
[F3] (DRUM)	Drum track on/off

* If the song contains a drum track, playback cannot be started from a point midway through the song. Playback will start from the beginning of the song when such songs are played back.

* You can't fast-forward or rewind a song that contains a drum track.

2. To stop, press the [▶/■] button.

The [▶/■] button will go dark, and song playback will stop.

MEMO

- In the DRUM KIT screen, you can hold down the [SONG] button and press the [▶/■] button to play/stop the song.
- If you press the [SONG]/[EXIT]/[DRUM KIT] button, you will return to the DRUM KIT screen but the song will continue playing.



Changing the Song Settings

1. In the SONG screen, press the [MENU] button.
The SONG MENU screen will appear.
2. Use the cursor buttons (▲/▼) or the [MENU] button to scroll the screen.
3. Press the [F1]–[F3] buttons to select the menu item whose settings you want to change, and use the value dial to edit the value.

Button	Value	Description
[F1] (VOLUME)	0–100	Song volume
[F2] (SPEED)	80–120 %	Song playback tempo (*)
[F3] (A-B)		Specifies the repeat playback setting (p. 29). If you press this while making the setting, repeat playback will be turned off. (*)
[F1] (LOOP)	ON	When the song has played back to the end, playback will return to the beginning of the song and continue.
	OFF	Playback will stop when the song has played back to the end.
[F2] (FOLDER)		Selects a folder within the USB flash drive (p. 28).
[F3] (INFO)		Displays information about the song (p. 29).

(*) This function is not available for songs that contain a drum track.

4. Press the [EXIT] button several times to return to the SONG screen.

Selecting a Folder

1. In the SONG MENU screen, press the [F2] (FOLDER) button.
The FOLDER SELECTION screen will appear.



2. Select a folder.

Button	Description
Cursor buttons (▲/▼)/ Value dial	Select a folder.
[F1] (BACK)	Show the higher-level folder.
[F2] (OPEN)	Show the lower-level folder.

3. Press the [F3] (OK) button to confirm your choice of folder.

MEMO

The files and folders in the folder you selected will play back.

Repeatedly Playing a Specified Region (A-B Repeat)

You can use the "A-B Repeat" function to repeatedly play back a specified region.

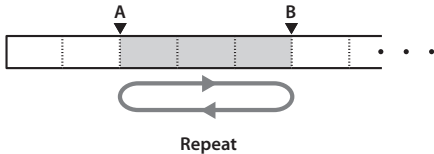

NOTE

This setting cannot be made if the repeat region is too short.

1. Select a song and play it back.
2. In the SONG MENU screen, press the [F3] (A-B) button.
The A-B REPEAT screen will appear, and the character "A" will blink.



MEMO

You can use the [F1] (◀◀)/[F2] (▶▶) buttons to fast-forward/rewind the song.

3. At the location where you want to start repeating, press the [F3] (SET A) button.
The "A" character will light, and the "B" character will blink.



4. At the location where you want to stop repeating, press the [F3] (SET B) button.
The "B" character will light, and the song will continue repeating between "A" and "B."



If you want to respecify the region, press the [F3] (RESET) button.
If you press the [F1] (CANCEL) button, conventional playback will resume and the A-B REPEAT screen will close.

Viewing Song Information

1. In the SONG MENU screen, press the [F3] (INFO) button.
The SONG INFORMATION screen will appear.

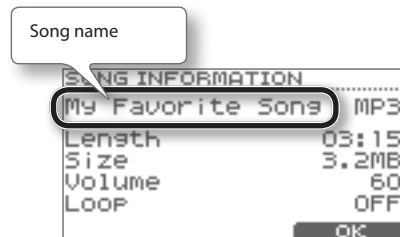

Display	Description
Length	Song playback duration
Size	File size
Volume	Song volume (p. 28)
Loop	Loop playback on/off (p. 28)

2. Press the [F3] (OK) button to close the screen.

Play Along with a Song and Record Your Performance (QUICK REC)

Here's how you can play the drums along with a song and record your performance.

- * You must first select the drum kit and song that you want to use for practicing (performing).
- * The sound from the MIX IN jack will not be recorded.

1. In the SONG screen, select a song.

2. Press the [Q] (QUICK REC) button.

The QUICK REC screen will appear, and the TD will be in record-standby mode.



3. Press the [▶/■] button to begin recording.



NOTE

- When recording begins, the previous recording will be completely erased.
- When you switch songs, the previous recording will be completely erased.
- You can't change the speed of a recorded song.

4. Play the drums along with the song.

5. Press the [▶/■] button to stop recording.

6. Once again press the [▶/■] button.

The recorded performance will play back.

7. Press the [▶/■] button to stop playback.

Where the recorded data is exported

When a USB flash drive is connected, your recorded data is automatically exported to the USB flash drive. Only the five most recent recorded performances will be exported as SMF data (p. 14).



The recorded data is saved in the following folder of the USB flash drive.

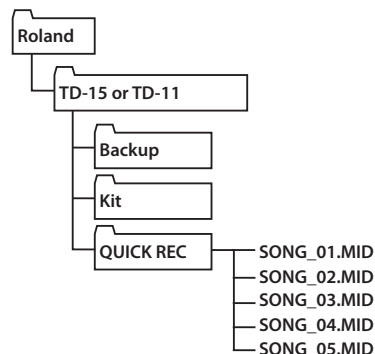

Practicing in Coach Mode

The TD's Coach mode is a unique set of exercises specifically designed to help build speed, accuracy and stamina, as well as develop better timing skills.

Throughout the Coach modes, you will discover that some of them have programmable parameters, allowing you to adapt the functions to your specific needs.

Selecting a Practice Menu

1. Press the [COACH] button so it's lit.

The COACH MENU screen will appear.

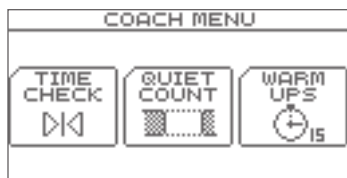

2. Select a menu item, and start practicing.

When you press a button, the corresponding practice menu item will start immediately.

Button	Menu item	Description
[F1]	TIME CHECK (p. 31)	Strengthens your ability to play accurate rhythms.
[F2]	QUIET COUNT (p. 32)	Strengthens your ability to maintain the tempo internally.
[F3]	WARM UPS (p. 32)	When you want to get warmed up before you begin practicing.

Operations common to Coach mode

Basic operations (e.g., changing the tempo, and starting/stopping) are the same in each of the three Coach mode items.

Operation	Button/Dial
Change the tempo	Value dial
Start	[F3] (START) / [A]
Stop	[F1] (STOP) / [A]
Make settings	[F2] (SETUP)
Exit Coach mode	[COACH]

When using Warm Ups, you can pause by pressing the [F3] (PAUSE) button.

Correctly Playing in Time with the Beat (TIME CHECK)

This mode lets you practice playing accurately along with the metronome.

Start practicing

In the COACH MENU screen, press the [F1] (TIME CHECK) button; practice will start immediately.

1. Strike the pad in time with the metronome.

The percentage of your strikes that were played with accurate timing is displayed as a “%” value.

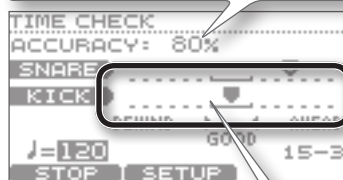

The screen will indicate whether your pad strikes match the beat sounded by the metronome.

Scoring

If Score (p. 31) is “ON,” the Time Check will automatically end when you’ve finished practicing the specified number of measures. Then your performance will be scored, and the results will appear in the screen.



Settings

In the TIME CHECK screen, press the [F2] (SETUP) button to access the settings screen.

Parameter	Value	Description
Score		Specifies whether the score will be shown in the screen.
	OFF	Your performance will not be scored. Only the timing will be checked.
	ON (4, 8, 16, 32 meas)	The score will be shown in the screen. You can also specify the number of measures you'll practice before being scored.
Grade		Specifies the strictness of scoring.
	EASY	Normal
	HARD	Timing will be checked more strictly.

Practicing in Coach Mode

Parameter	Value	Description
Display 1 Display 2		In the screen, select the pad for which a timing graph will be shown.
Gauge	LEFT BEHIND	The left side of the timing graph is shown as BEHIND (late).
	LEFT AHEAD	The left side of the timing graph is shown as AHEAD (early).

* You can press the [F2] (METRO) button to make metronome settings (p. 13).

Developing Internal Timing Sense (QUIET COUNT)

This mode will help you develop a good sense of time/tempo.

For the first few measures, the metronome will sound at the specified volume; over the next few measures, the volume will diminish until it is nearly inaudible. This cycle of several measures will continue until you stop it.

Start practicing

In the COACH MENU screen, press the [F2] (QUIET COUNT) button; practice will start immediately.

1. Strike the pads in time with the metronome.

- The metronome will sound during the first few measures. When you reach the last measure during which the metronome will sound, the screen will indicate "Ready."



- When the metronome stops sounding, the screen indication will change to "Quiet." Continue striking the pads during this time.



- After the Quiet region, the proportion of your strikes that were played at an accurate tempo are shown as a "%" value.



Settings

In the QUIET COUNT screen, press the [F2] (SETUP) button to access the settings screen.

Parameter	Value	Description
Measures	2, 4, 8, 16 (Measures)	Specify the length (measures) of the interval for which the metronome will alternate between "Sounding" and "Quiet."
		Of the measures specified by "Measures," this setting specifies the length of the measures that will be "Quiet."
Quiet	RANDOM	The length of the Quiet interval will randomly change each time.
	1, 2, 4	Specifies the length (number of measures) of the Quiet interval. * This setting cannot be longer than half of the Measures value.

* You can press the [F2] (METRO) button to make metronome settings (p. 13).

WARM UPS

In this mode you'll successively practice steps 1-3, be graded on your performance at each step, and then receive a final evaluation.

You can choose one of three courses, ranging from easy to difficult. You can also adjust the tempo according to your level of skill.

MEMO

After you've started WARM UPS, you can press the [F3] (PAUSE) button to pause the WARM UPS.



To resume practicing, press the [F3] (START) button once again.

If you're finished with WARM UPS, press the [F1] (STOP) button.

Step 1: Change-Up

In this step, the rhythm type will change every two measures.

Starting from half notes, the note values will gradually become shorter, and will then return to half notes; this change in rhythms will be repeated.



Step 2: Auto Up/Down

The tempo will gradually be raised and lowered.

The tempo will increase by 1 BPM (beat-per-minute) for each beat until the metronome reaches the upper limit; then the tempo will continue slowing down by 1 BPM until it reaches the initial tempo.

* Auto Up/Down will be executed if Duration(p. 33) is 10 MINS or 15 MINS.



* The current tempo value will be the lower tempo limit.

MEMO

While practicing, you can press the [F1] (SET MAX) button to specify the current tempo as the upper limit; if you press the [F1] (CLR MAX) button, the upper tempo limit will return to 260.

Step 3: Time Check

At this step, the accuracy of your playing will be checked against the metronome. You can see in the screen if you are ahead, behind or on the beat.



Overall evaluation

This grades your performance at each step, and displays the overall evaluation.



Evaluation (display)	EXCELLENT!, VERY GOOD!, GOOD, AVERAGE, START OVER
----------------------	---

Settings

In the WARM UPS screen, press the [F2] (SETUP) button to access the settings screen.

Parameter	Value	Description
Duration	5 MINS	Time required: 5 minutes Change-Up: 2 minutes Time Check: 3 minutes
	10 MINS	Time required: 10 minutes Change-Up: 3 minutes Auto Up/Down: 3 minutes Time Check: 4 minutes
	15 MINS	Time required: 15 minutes Change-Up: 5 minutes Auto Up/Down: 5 minutes Time Check: 5 minutes
Grade	EASY	Normal
	HARD	Timing will be checked more strictly.
Change-Up		Step 1: Selects the pattern by which the rhythm will vary during Change-up.
Max Tempo		Step 2: Specifies the upper tempo limit during step 2: Auto Up/Down.

* You can press the [F2] (METRO) button to make metronome settings (p. 13).

Settings for the Entire TD (SYSTEM)

Parameters that apply to the entire TD, such as the metronome settings and the pad sensitivity, are called “system parameters.” Here we’ll explain the procedure for setting the system parameters, and what each parameter does.

Basic procedure

1. In the DRUM KIT screen (p. 11), press the [MENU] button.

The KIT MENU screen will appear.

2. Press the (▼) cursor button to scroll the screen until the SYSTEM icon appears.

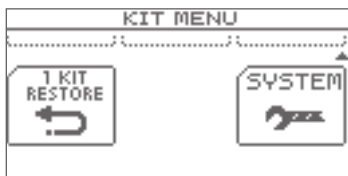

3. Press the [F3] (SYSTEM) button.

The SYSTEM screen will appear.



4. Use the cursor buttons (▲/▼) to select the desired menu of settings.

The following menus are available.

Menu	Description	Page
Options	Settings for display contrast and power (Auto Off)	p. 35
Metronome	Metronome settings	p. 36
TD-15 ONLY Pad Control	Allows you to set the function of the pad connected to the TRIGGER IN AUX jack.	p. 36
MIDI	MIDI-related settings	p. 37
USB Memory	Using a USB flash drive	p. 38
Wireless	Refer to the separate document “About the Wireless LAN Function.”	—
Pad Settings	Pad settings	p. 41
Information	View information about the TD itself	p. 46
Factory Reset	Reset the TD to its factory settings	p. 46

5. Press the [F3] (ENTER) button.

The corresponding settings screen will appear.

6. Use the cursor buttons (▲/▼) to select a parameter, and use the value dial to change the value of the parameter.

7. Press the [EXIT] button several times to return to the DRUM KIT screen.

Overall Settings for the TD (Options)

For details on the procedure, refer to “Basic procedure” (p. 34).

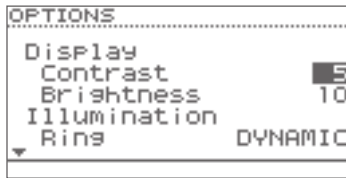

Parameter	Value	Description
Display Contrast	1–10	Adjusts the contrast of the display. MEMO In the DRUM KIT screen, you can adjust this by holding down the [MENU] button and turning the value dial.
Display Brightness	1–10	Adjusts the brightness of the display.
TD-15 ONLY Illumination Ring		You can make the ring of the value dial light up in synchronization with your performance.
	OFF	The ring will not light.
	DYNAMIC	The ring will light according to the dynamics of your playing.
	KICK	The ring will light when you play the kick drum.
	TEMPO	The ring will light in synchronization with the tempo setting.
TD-15 ONLY Illumination Kit Buttons		You can make the [DRUM KIT] buttons light up.
	OFF	The [DRUM KIT] buttons will not light.
	ON	The [DRUM KIT] buttons will light.
Auto Off		When shipped from the factory, the TD is set to automatically power-off when 30 minutes have elapsed since it was last played or operated. Approximately five minutes before the power turns off, a message will appear in the display.
	OFF	The power will not turn off automatically.
	10 MINS	The power will turn off automatically when 10 minutes have elapsed.
	30 MINS	The power will turn off automatically when 30 minutes have elapsed.
	4 HOURS	The power will turn off automatically when four hours have elapsed.
USB Audio Volume	0–100	Adjusts the volume when using the TD to listen to audio data played back from your computer.
Write Protect	OFF, ON	If the Write Protect setting is ON, it will not be possible to save any settings.

Metronome Setup (Metronome)

- In step 4 of the basic procedure (p. 34), choose "Metronome" and press the [F3] (ENTER) button to access the METRONOME SETUP screen.

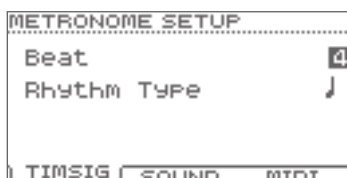

- From the following list, select the item that you want to set.

Button	Description
[F1] (TMSIG)	Set the time signature of the metronome.
[F2] (SOUND)	Set the volume of the metronome.
TD-15 ONLY [F3] (MIDI)	Use incoming MIDI messages from your DAW software etc. to sound the metronome.

- Use the cursor buttons (▲/▼) to select a parameter, and use the value dial to edit the setting.

Parameter	Value	Description
TMSIG		
Beat	1–9	Metronome time signature
Rhythm Type	Half notes, quarter notes, eighth notes, eighth note triplets, sixteenth notes (shown as a note symbol)	Metronome interval
SOUND		
Sound	15 types	Metronome tone
Volume	0–10	Metronome volume
Pan	L15–CENTER–R15	Metronome panning
TD-15 ONLY Output	OUTPUT+ PHONES, PHONES ONLY	Metronome output destination
TD-15 ONLY MIDI		
MIDI Channel	OFF, 1–16	MIDI channel that will sound the metronome
Note# Accent	0 (C-1)–127 (G9)	Note number for the first beat
Note# Normal	0 (C-1)–127 (G9)	Note number for subsequent beats

Using a Pad as a Switch (Pad Control) **TD-15 ONLY**

A pad connected to the TRIGGER IN AUX jack can function as a switch to change drum kits or to start/stop a song.

* This setting is valid only in the DRUM KIT screen and the SONG screen.

NOTE

You must select the correct pad type (p. 41) for the pad that's connected.

- In step 4 of the basic procedure (p. 34), choose "Pad Control" and press the [F3] (ENTER) button to access the PAD CONTROL screen.
- Use the cursor buttons (▲/▼) to move the cursor to "AUX Head" or "AUX Rim."

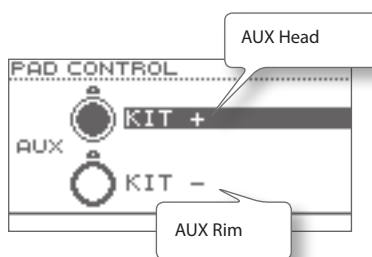

- Use the value dial to select the function that you want to control.

Function	Description
OFF	Disables the pad control function.
KIT+	Selects the next kit.
KIT-	Selects the previous kit.
SONG PLAY	Starts song playback.
SONG STOP	Stops song playback.
SONG PLAY/ STOP	Starts/stops song playback each time you strike the pad.
TAP TEMPO	Set the tempo according to the interval at which you strike the pad.

MIDI-Related Settings (MIDI)

Here you can set MIDI settings for the entire TD.

There are many possibilities when using MIDI, such as:

Use the pads to play external MIDI instruments

You can layer sounds on the TD as well as play sounds from MIDI sound modules and samplers.



Use the TD as a sound module

Using the DAW software, you can use the TD as a dedicated drum sound module.

Control an external video device

When connected to a video device, you can use the TD to switch images.

For details on the procedure, refer to "Basic procedure" (p. 34).

Parameter	Value	Description
[F1] (MIDI)		
Std MIDI Setup Lock	OFF, ON	Turn this ON if you're using V-Drums Friend Jam or V-Drums Tutor (sold separately) (p. 47).
MIDI Channel	OFF, 1–16	Specifies the transmit/receive channel
Local Control	OFF, ON	<p>Specifies whether the TD's pads will be connected to the internal sound generator (ON) or disconnected from the internal sound generator (OFF).</p> <p>Normally you will leave this "ON." However, you should choose the "OFF" setting when you're using the TD's pads only to control an external sound module, or when using the TD in conjunction with DAW software on your computer.</p> <p>Using Local Control</p> <p>When using the TD in conjunction with your DAW software, the notes you play by striking the pads might be sounded in duplicate together with the notes that are "echoed-back" by your DAW software.</p> <p>If this occurs, set Local Control to the "OFF" setting so that the TD's pads will be disconnected from the internal sound generator, allowing you to use the TD in conjunction with the DAW software on your computer as shown in the illustration.</p>
Note Chase	OFF, ON	If this function is "ON," incoming MIDI data that matches a pad's assignment will cause the screen to show the edit screen of the instrument used by that pad, or cause the cursor to move.
Prog Change Tx	OFF, ON	Specifies whether program change messages will be transmitted (ON) or not transmitted (OFF). If this is "ON," a program number will be transmitted when you switch drum kits on the TD.
Prog Change Rx	OFF, ON	Specifies whether program change messages arriving from DAW software on your computer will be received (ON) or ignored (OFF). If this is "ON," incoming program changes will select the drum kit of the corresponding number.
[F2] (VISUAL)		
Visual Control	OFF, ON	Turn this "ON" if you want to control a video device (sold separately) in synchronization with your performance (p. 47). This will always be "OFF" when you turn on the power.
Control Mode	MVC, V-LINK	Set this as appropriate for the video device that's connected.
MIDI Channel	1-16	MIDI channel used to switch images.

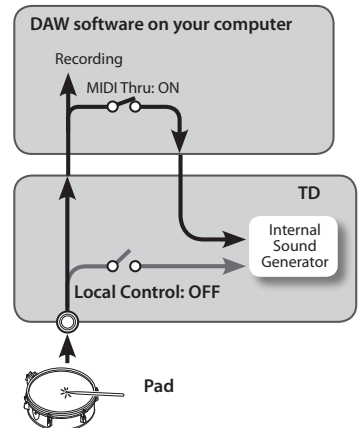

Using USB Flash Drive (USB Memory)

1. First connect your USB flash drive to the TD (p. 9).
2. In step 4 of the basic procedure (p. 34), choose "USB Memory" and then press the [F3] (ENTER) button to access the USB MEMORY screen.



3. Use the cursor buttons (▲/▼) to select the desired menu item.

You can choose from the following menu items.

Menu	Description	Page
Save Backup	Save data to the USB flash drive.	p. 38
Load Backup	Load data from the USB flash drive into the TD.	p. 39
Delete Data	Delete data from the USB flash drive.	p. 39
Information	View information about the USB flash drive.	p. 40
Format	Format the USB flash drive.	p. 40

Saving Data to a USB Flash Drive (Save Backup)

Here's how to save TD data to a USB flash drive.

Data that will be saved

- All drum kits
- System settings



1. Choose "Save Backup" and press the [F3] (ENTER) button (p. 38).

2. Use the value dial to select the save-destination number.

Next you can assign a name to the data that will be saved.

If you don't need to assign a name, proceed to step 7.

3. Press the [F2] (NAME) button.

The SAVE screen will appear.

You can assign a name of up to eight characters.



4. Press the [F1] (←) or [F2] (→) button to move the cursor to the character that you want to change.

5. Use the value dial to change the character.

Here you can hold down the [F3] (DEL/INS) button and use the [F1][F2] buttons to delete or insert a character.

Button	Description
[F3]+[F1] (DEL)	Deletes the character at the cursor location, and moves the subsequent characters one place to the left.
[F3]+[F2] (INS)	Inserts a space at the cursor location and moves the subsequent characters one place to the right.

6. When you've assigned a name, press the [EXIT] button to return to the previous screen.

7. Press the [F3] (SAVE) button.

* If you select a number in which data has already been saved, and then press the [F3] (SAVE) button, a confirmation message will appear, asking you whether you really want to overwrite the data. If you decide to cancel, press the [F1] (CANCEL) button and then reselect the save-destination number.

If it is OK to overwrite the existing data, press the [F3] (OK) button.

When the data has been saved, the screen will indicate "Completed."

Loading Data from a USB Flash Drive Back into the TD (Load Backup)

Data you've saved on a USB flash drive can be loaded back into the TD.

NOTE

- All data and settings in the TD will be overwritten.
- You can't load data if "Write Protect" (p. 35) is turned ON.



1. Choose "Load Backup" and press the [F3] (ENTER) button (p. 38).
2. Use the value dial to select the data that you want to load.
3. Press the [F3] (LOAD) button.

A confirmation message will appear.



If you decide to cancel, press the [F1] (CANCEL) button.

4. To load the data, press the [F3] (OK) button. When the data has been loaded, the screen will indicate "Completed."

Deleting Data from a USB Flash Drive (Delete Data)

Here's how to delete data that's been saved on a USB flash drive.

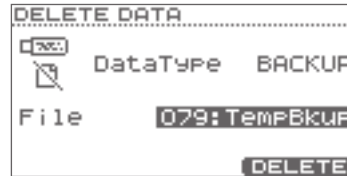

1. Choose "Delete Data" and press the [F3] (ENTER) button (p. 38).
2. Use the cursor buttons (▲/▼) to choose "Data Type," and then use the value dial to choose the type of data that you want to delete.

Data type	Description
1 KIT	A drum kit saved by "1 KIT SAVE" (p. 24)
BACKUP	Backup data

3. Use the cursor buttons (▲/▼) to choose "File," and then use the value dial to select the number of the data that you want to delete.
4. Press the [F3] (DELETE) button. A confirmation message will appear.



If you decide to cancel, press the [F1] (CANCEL) button.

5. To delete the data, press the [F3] (OK) button. When the data has been deleted, the screen will indicate "Completed."

Viewing Information About the USB Flash Drive (Information)

Here's how to view information about the USB flash drive.



Parameter	Description
Backups	Number of data backups
Kits	Number of saved drum kits
Size Used	Amount of memory used on the USB flash drive

1. Choose "Information" and press the [F3] (ENTER) button (p. 38).
2. When you've viewed the information, press the [F3] (OK) button to close the screen.

Formatting a USB Flash Drive (Format)

NOTE

When you execute the Format operation, all data on the USB flash drive will be erased.



1. Choose "Format" and press the [F3] (ENTER) button (p. 38).
2. Press the [F3] (FORMAT) button.
A confirmation message will appear.



If you decide to cancel, press the [F1] (CANCEL) button.

3. If you're sure that you want to format the USB flash drive, press the [F3] (OK) button.
Once again, a confirmation message will appear.



If you decide to cancel, press the [F1] (CANCEL) button.

4. If you're sure that you want to format the USB flash drive, press the [F3] (OK) button.
When formatting has been completed, the screen will indicate "Completed."

Optimizing the Pad Settings (Pad Settings)

1. In step 4 of the basic procedure (p. 34), choose “Pad Settings” and then press the [F3] (ENTER) button to access the PAD SETTINGS screen.

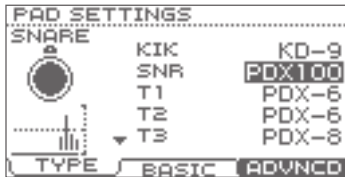

2. Choose one of the following items to edit.

Button	Description	Page
[F1] (TYPE)	Specify the type of pad	p. 41
[F2] (BASIC)	Adjust the pad sensitivity	p. 42
[F3] (ADVNCD)	Make advanced settings for the trigger parameters	p. 43

3. Strike a pad to select the pad for which to make settings.
4. Use the cursor buttons (▲/▼) to select a parameter, and use the value dial to edit the value.

Specifying the Type of Pad [F1] (TYPE)

You can select the type of pad you’re using (Pad Type) so the TD will accurately receive the signal from the pad.

Parameter	Value	Description
Pad Type	KD-7, KD-8, KD-9, KD-120, KD-140, PD-8, PD-85, PD-105, PD-108, PD-125, PD-128, PDX-6, PDX-8, PDX100, CY-5, CY-8, CY-12C, CY-13R, CY-14C, CY-15R, VH-11, RT-10K, RT-10S, RT-10T	The pad type is a collection of parameters optimized for specific models of pad. If you select the appropriate trigger type for each pad you’ve connected, all parameters (except for Crosstalk Cancel) will be set to the optimal values. However, these are only the typical values, so you may need to make fine adjustments according to how you’ve attached the pads or the way in which you’re using them.

The following pads should be connected to the “SNR,” “T1–3,” or “AUX” trigger input.

If these pads are connected to any other trigger input, the signal of a rim strike will not be detected correctly.

Pads	PD-85, PD-105, PD-108, PD-125, PD-128, PDX-6, PDX-8, PDX-100, RT-10S
------	--

Setting the Pad Sensitivity [F2] (BASIC)

When you specify the pad type (p. 41), the following settings (basic trigger parameters) are automatically set to the values appropriate for each pad, meaning that you will normally not need to adjust them. If you wish to make detailed adjustments, you can edit the following parameters for each pad.



MEMO

The velocity monitor at the left of the screen indicates the velocity.

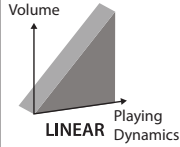
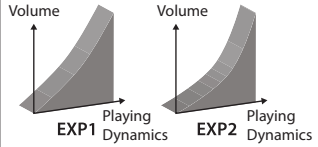
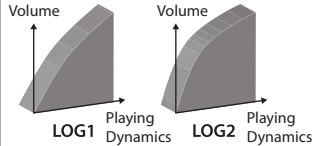
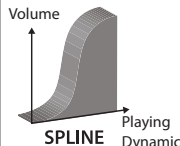
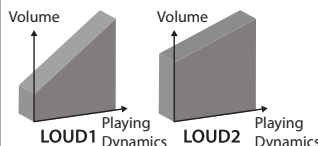
Parameter	Value	Description
Pad Type	Refer to p. 41.	
Sensitivity	1–32	<p>You can adjust the sensitivity of the pads to accommodate your personal playing style. This allows you to have more dynamic control over the sound volume, based on how hard you play. Higher sensitivity allows the pad to produce a loud volume even when played softly. Lower sensitivity will keep the pad producing a low volume even when played forcefully.</p>
Threshold	0–31	<p>This setting allows a trigger signal to be received only when the pad is above a determined dynamic level (velocity). This can be used to prevent a pad from sounding because of vibrations from other pads.</p> <p>In the example at the right, B will sound but A and C will not sound.</p> <p>When set to a higher value, no sound is produced when the pad is struck lightly.</p> <p>Gradually raise the “Threshold” value while striking the pad.</p> <p>Check this and adjust accordingly. Repeat this process until you get the perfect setting for your playing style.</p>
Curve		<p>This setting allows you to control the relation between playing velocity (striking force) and changes in volume. Adjust this curve until the response feels as natural as possible.</p>
	LINEAR	<p>The standard setting. This produces the most natural correspondence between playing dynamics and volume change.</p> 
	EXP1, EXP2	<p>Compared to LINEAR, strong dynamics produce a greater change.</p> 
	LOG1, LOG2	<p>Compared to LINEAR, a soft playing produces a greater change.</p> 
	SPLINE	<p>Extreme changes are made in response to playing dynamics.</p> 
	LOUD1, LOUD2	<p>Very little dynamic response, making it easy to maintain strong volume levels. If you're using a drum trigger as an external pad, these settings will produce reliable triggering.</p> 

Advanced Settings for the Trigger Parameters [F3] (ADVNC D)

When you specify the Pad Type (p. 41), the settings in this screen (advanced trigger parameters) will automatically be set to the values that are most suitable for that type of pad; this means that with the exception of crosstalk cancellation, you will normally not need to edit these settings.

You should make fine adjustments to these parameters for each pad only if you experience the problems described in the explanation of each parameter.

1. Press one of the [F1]–[F3] buttons to select the item that you want to edit.
2. Strike a pad to specify the pad whose settings you want to edit.
3. Use the cursor buttons (▲/▼) to select a parameter.
4. Use the value dial to edit the value.

[F1] (SCAN)

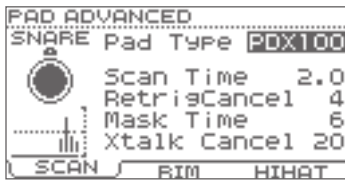

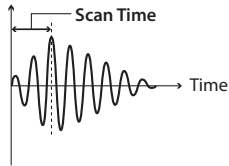
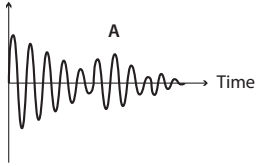
Parameter	Value	Description
Pad Type	Refer to p. 41.	
Scan Time	0–4.0 (ms)	<p>Specifies the detection time for the trigger signal.</p> <p>Since the rise time of the trigger signal waveform may differ slightly depending on the characteristics of each pad or acoustic drum trigger (drum pickup), you may notice that identical hits (velocity) may produce sound at different volumes. If this occurs, you can adjust the “Scan Time” so that your way of playing can be detected more precisely.</p> <p>While repeatedly hitting the pad at a constant force, gradually raise the Scan Time value from “0,” until the resulting volume stabilizes at the loudest level. At this setting, try both soft and loud hits, and make sure that the volume changes appropriately.</p> <p>* As the value is set higher, the time it takes for the sound to be played increases. Set this to the lowest value possible.</p> 
Retrig Cancel	1–16	<p>This setting prevents spurious re-triggering.</p> <p>Important if you are using acoustic drum triggers. Such triggers can produce altered waveforms, which may also cause inadvertent sounding at Point A in the figure (Re-trigger).</p> <p>This occurs in particular at the decaying edge of the waveform. Retrig Cancel detects such distortion in and prevents re-triggering from occurring.</p> <p>While repeatedly striking the pad, raise the “Retrig Cancel” value until re-triggering no longer occurs.</p> <p>* Although setting this to a high value prevents re-triggering, it then becomes easy for sounds to be omitted when the drums played fast (roll etc.). Set this to the lowest value possible while still ensuring that there is no re-triggering.</p> <p>MEMO</p> <p>You can also eliminate this problem of re-triggering with the Mask Time setting (p. 44). Mask Time does not detect trigger signals if they occur within the specified amount of time after the previous trigger signal was received. Retrig Cancel detects the attenuation of the trigger signal level, and triggers the sound after internally determining which trigger signals were actually generated when the head was struck, while weeding out the other false trigger signals that need not trigger a sound.</p> 

Settings for the Entire TD (SYSTEM)

Parameter	Value	Description
Mask Time	0–64 (ms)	<p>This setting prevents double triggering.</p> <p>When playing a kick trigger, the beater can bounce back and hit the head a second time immediately after the intended note—with acoustic drums sometimes the beater stays against the head—is causes a single hit to “double trigger” (two sounds instead of one). The Mask Time setting helps to prevent this. Once a pad has been hit, any additional trigger signals occurring within the specified “Mask Time” (0–64 msec) will be ignored.</p> <p>Adjust the “Mask Time” value while playing the pad.</p> <p>When using a kick trigger, try to let the beater bounce back and hit the head very quickly, then raise the “Mask Time” value until there are no more sounds made by the beater rebound.</p> <p>* When set to a high value, it will be difficult to play very quickly. Set this to as low a value as you can.</p> <p>MEMO</p> <p>If two or more sounds are being produced when you hit the head just once, then adjust Retrig Cancel (p. 43).</p>
Xtalk Cancel	0–80	<p>This setting cancels “crosstalk,” which means that when you play one pad you hear a sound coming from another pad. This can happen when two pads are installed on the same stand.</p> <p>In some cases you can prevent crosstalk by increasing the distance between the two mounted pads.</p> <p>Crosstalk Example: If you hit the snare pad and the tom 1 also sounds</p> <p>While striking the Snare pad, gradually increase the “Xtalk Cancel” value for the tom 1 pad until the tom 1 pad no longer sounds when you hit the Snare pad. If you raise the “Xtalk Cancel” higher, the tom 1 pad will be less prone to receive crosstalk from other pads.</p> <p>* If the value is set too high, and two pads are played simultaneously, the one that is struck less forcefully may not sound. Be careful and set this parameter to the minimum value required to prevent crosstalk.</p>

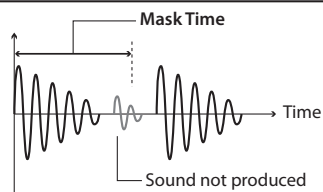

[F2] (RIM)

Parameter	Value	Description
Trig Type	Refer to p. 41.	
Rim Gain	0–8.0	<p>When a PD-8/PD-85/PD-105/PD-108/PD-125/PD-128, PDX-6/PDX-8/PDX-100, CY series pad, VH-11, or RT-10S is connected, you can adjust the relation between your playing velocity (force) on the rim/edge and the resulting volume level.</p> <p>Higher value allows the rim/edge to produce a loud volume even when played softly. Lower value will keep the rim/edge producing a low volume even when played forcefully.</p>
Head/Rim Adj	0–80	<p>When a PD-85/PD-105/PD-108/PD-125/PD-128, PDX-6/PDX-8/PDX-100, or RT-10S is connected, you can adjust the sensitivity of the head response.</p> <p>There are some cases that you have a rim sound unexpectedly when you hit the head strongly. You can improve this situation with decreasing the value of “Head/Rim Adj.” When you set the value too big, it might be difficult to play the rim sound.</p>
Xstick Adj	-9–+9	<p>Specifies the striking force at which to switch between the cross-stick sound and the open rim shot sound.</p> <p>With positive (+) settings, the cross stick sound will be heard even for strong strikes.</p>

[F3] (HIHAT)

Parameter	Value	Description
Pedal HH Sens	-5–+5	<p>Adjusts the sensitivity for playing foot-close or foot-splash notes.</p> <p>Positive (“+”) settings allow louder sounds to be produced even when you step lightly on the pedal.</p>

Connecting the VH-11 and making settings on the TD

Connections

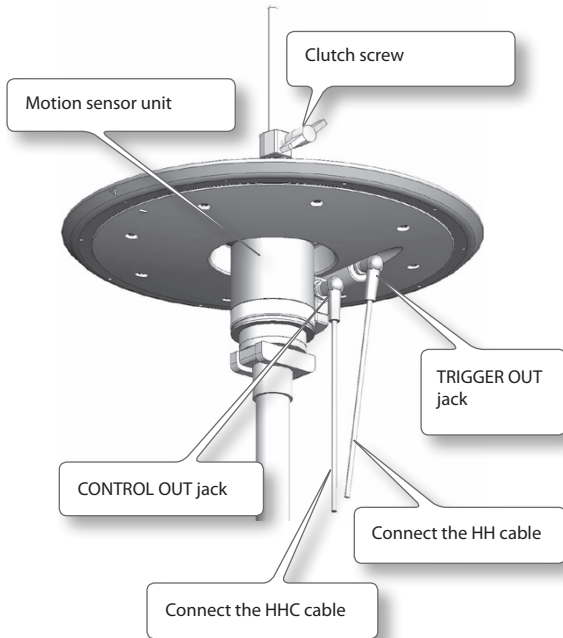

Settings

1. Make sure that the VH-11 is correctly connected to the TD.
2. Set up the hi-hat, take your foot off the pedal, and power-on the TD.
 - * It will be impossible to make the adjustment correctly if the hi-hat is touching the motion sensor when you turn on the power.
3. Loosen the clutch screw, and allow the hi-hat to rest naturally on top of the motion sensor unit.
4. Proceed up through step 5 of the basic procedure (p. 34) to access the PAD SETTINGS screen.
5. Press the [F1] (TYPE) button.
6. Use the cursor buttons (▲/▼) to select "HH."
7. Use the value dial to select "VH-11."

8. Press the [F3] (ADVNC D) button, and then press the [F3] (HIHAT) button.

The following screen will appear.

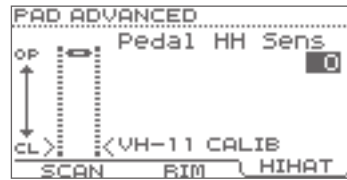

9. While you watch the meter that's displayed in the left side of the screen, turn the VH-11's VH offset adjustment screw to adjust it.

Adjust the screw so that the ►◀ appears in the meter.

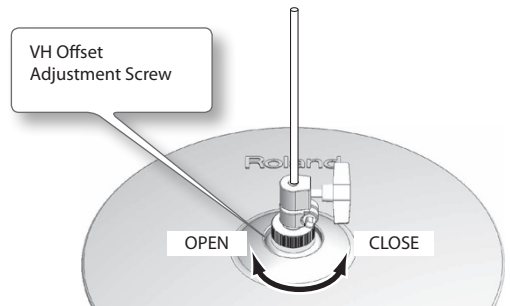

VH Offset Adjustment Points

If the closed hi-hat sound is difficult to attain, rotate the VH offset adjustment screw towards "CLOSE."

If the open hi-hat sound is difficult to attain, rotate the screw towards "OPEN."

NOTE

If the sound cuts off when you strike the hi-hat forcefully, rotate the VH Offset adjustment screw towards "OPEN."

10. Adjust other parameters as needed.

NOTE

If you don't set up the VH-11 correctly, it may not operate correctly.

Settings for the Entire TD (SYSTEM)

Viewing Information About the TD (Information)

Here you can view information about the TD itself. For details on the procedure, refer to “Basic procedure” (p. 34).

Item	Description
Program Ver.	System program version

Restoring the Factory Settings (Factory Reset)

This “factory reset” operation restores all drum kits and system settings in the TD to their factory-set state.

NOTE

- All data and settings in the TD will be lost. If the TD contains any data or settings that you want to keep, you must save them to a USB flash drive before you proceed (p. 38).
- This operation cannot be executed if “Write Protect” (p. 35) is ON.

1. In step 4 of the basic procedure (p. 34), choose “Factory Reset” and then press the [F3] (ENTER) button to access the FACTORY RESET screen.



2. Use the value dial to select the type of data that you want to reset.

Parameter	Value	Description
Target	ALL KITS	All kits
	SYSTEM	System settings
	ALL	All data

3. Press the [F3] (RESET) button.

A confirmation message will appear.

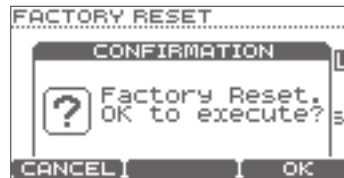

If you decide to cancel, press the [F1] (CANCEL) button.

4. If you're sure you want to execute the factory reset, press the [F3] (OK) button.

Once again, a confirmation message will appear.



If you decide to cancel, press the [F1] (CANCEL) button.

5. If you're sure you want to execute the factory reset, press the [F3] (OK) button.

When the factory reset has been completed, the screen will indicate “Completed.”

Connecting to a Computer or Video Device

Connecting to Your Computer via USB

If you use a commercially available USB cable to connect the TD's COMPUTER port to a USB port of your computer, sound played back by your computer can be heard through the TD, and sounds played by the TD can be recorded on your computer.

You'll also be able to use software such as V-Drums Friend Jam and V-Drums Tutor to enjoyably practice your drumming.

What is V-Drums Friend Jam?

V-Drums Friend Jam is a drummer's social networking tool that lets you use the V-Drums and your computer to enjoy practicing/competing with friends around the world. Practice songs can be automatically downloaded from the internet, and are also linked with Twitter.

Access <http://vdru.ms/fj> and download it!



What is V-Drums Tutor?

The V-Drums Tutor (sold separately) is a drumming practice software designed to be used with Roland V-Drums, making your practice time simple, enjoyable, challenging and effective.

Installing the USB Driver

Before connecting the TD to your computer, you must first install the USB driver.

1. Install the USB driver in your computer.

The dedicated driver for the TD-15 and TD-11 is included in the attached CD-ROM, or you can download it from the Roland website.

Roland website
<http://www.roland.com/>

For the operating requirements, refer to the Roland website. The driver program and installation procedure will differ depending on your system. Please carefully read the Readme.htm included with the files you downloaded.

Connecting the TD to the Computer

1. Use a commercially available USB cable to connect the COMPUTER port located on the TD's top panel with your computer's USB port.

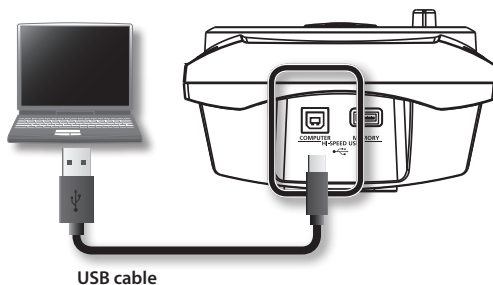

* Use a USB cable that supports USB 2.0 Hi-Speed.

Controlling Images

By connecting the TD to a video device that supports MIDI Visual Control or V-LINK, you can control images in synchronization with your performance.

What is the MIDI Visual Control?



MIDI Visual Control is an internationally-used recommended practice that was added to the MIDI specification so that visual expression could be linked with musical performance. Video equipment that is compatible with MIDI Visual Control can be connected to electronic musical instruments via MIDI in order to control video equipment in tandem with a performance.

What is the V-LINK? **V-LINK**

V-LINK is a function that allows music and images to be performed together. By using MIDI to connect two or more V-LINK compatible devices, you can easily enjoy a wide range of visual effects that are linked to the expressive elements of a music performance.

Use a MIDI cable to connect the TD's MIDI OUT connector to your video device.

When you turn Visual Control on (p. 37), the MVC or V-LINK icon will appear in the DRUM KIT screen.



Troubleshooting

If you don't hear sound, or if the system does not operate as you expect, please check the following points first.

If you are still unable to resolve the problem, contact your retailer, the nearest Roland Service Center, or an authorized Roland distributor, as listed on the "Information" page.

Problem	Items to check	Action	Page
No sound	Is the connection cable correctly connected to the TRIGGER INPUT connector?	Check the connections.	—
	Are the cables correctly connected to each pad and pedal?		
	Are the cables correctly connected to the TD's OUTPUT jacks or the PHONES jack?		
	Are the cables correctly connected to the input jacks of your amp or audio system?		
	Could there be a problem with the connection cables?	Try using other cables.	—
	Could the [VOLUME] knob be turned all the way to the left?	Try raising the volume of the TD. If you're using the TD-15, check the side panel [VOLUME] knob as well.	p. 7
	Have you made the correct input selection setting on your amp or audio system?	Check your amp or audio system.	—
	Are the volume settings of your amp or audio system appropriate?	Try raising the volume of your amp or audio system.	—
USB flash drive is not recognized Songs saved on the USB flash drive will not play back correctly Can't play back MP3/WAV files	Check the type of USB flash drive.	Use a USB flash drive sold by Roland. We cannot guarantee correct operation if any other product is used.	—
	Check the format of the USB flash drive.	The TD can use USB flash drives that are formatted in FAT format. Reformat the USB flash drive using the TD.	p. 40
	Does the TD support the sampling frequency and bit rate of the MP3 file, or the sampling frequency and bit depth of the WAV file?	Use MP3/WAV files that the TD supports.	p. 26
	Playback may be unable to keep up if you raise the playback speed or change the pitch of a high bit-rate MP3.		—
Can't save the TD's data to a USB flash drive	Is there sufficient free space on the USB flash drive?	Delete unneeded files from the USB flash drive, or use a higher-capacity USB flash drive.	p. 39
Can't correctly set the A-B repeat times	It's not possible to set the "A" and "B" times any closer than one second.	Make sure that there is at least one second between the two times.	p. 29
	When using an MP3 file, it might not be possible to play back the A-B repeat region correctly.		
Computer does not recognize the TD	Is the TD correctly connected to your computer?	Check the connection to your computer.	p. 47
	Is the USB driver installed?	You must first install the USB driver in your computer.	
	Make sure that the USB cable connecting the TD to your computer's USB port is compatible with USB 2.0 Hi-Speed.	Use a computer and cable that support USB 2.0 Hi-Speed.	

Error Messages

If an error message is displayed in the TD's screen, the TD was unable to operate correctly or was operated inappropriately. Take the appropriate action listed below.

Message	Meaning	Action
Error messages related to MIDI		
MIDI buffer full.	A large amount of MIDI messages was received in a short time, and the TD was unable to process them.	Reduce the amount of MIDI messages being transmitted to the TD.
MIDI Tx buffer full.	Due to the excessive amount of data that the TD needed to transmit, MIDI messages could not be output correctly.	Reduce the amount of data being transmitted.
Error messages related to USB		
USB memory full.	The USB flash drive does not have enough free space.	Either delete unneeded data, or use another USB flash drive.
Check the USB memory.	The USB flash drive is not working correctly.	Check the USB flash drive.
Could not read this file.	The specified data does not exist on the USB flash drive. Alternatively, the saved data has been damaged.	Check the USB flash drive.
Unsupported format.	The file format or song format is one that the TD cannot read.	Check the file. For the supported song formats, refer to p. 26.
USB device error.	Either the connected USB flash drive is one that the TD cannot use, or a foreign object has entered the MEMORY port and caused an electrical short.	Immediately disconnect the connection, and check whether a foreign object might have entered the MEMORY port.
USB memory busy.	Data could not be read fast enough from the USB flash drive.	<ul style="list-style-type: none"> • If this error message appears when playing back high bit-rate MP3 data, or when you've raised the playback speed of MP3 data, you may be able to solve the problem by lowering the bit rate or setting the speed to normal. • Use a USB flash drive sold by Roland.
Error messages related to the TD's internal memory		
Internal memory full.	The QUICK REC storage capacity is full, and recording has stopped.	—
Error messages related to the system		
Device error.	There is a problem with the internal system.	Contact your retailer, the nearest Roland Service Center, or an authorized Roland distributor, as listed on the "Information" page.
Data memory was damaged.	There is a problem with internal memory.	A factory reset will be executed automatically.
Other messages (* These are not errors)		
The module will turn off soon.	The power will soon turn off because of the "Auto Off" setting.	If you don't want the power to turn off, press any button or strike a pad. You can also disable the "Auto Off" setting so that the power does not turn off automatically (p. 35).
USB memory is not connected here.	A USB flash drive is not connected to the TD.	Connect a USB flash drive.
This page is invalid when Std MIDI Setup Lock is on.	If Std MIDI Setup Lock is ON, the settings of this page are ignored.	To enable these settings, turn Std MIDI Setup Lock off (p. 37).
Write Protect is ON.	The operation cannot be executed because Write Protect is on.	If you want to execute this operation, turn Write Protect off (p. 35).
Not possible if recorded drum data exists.	This function cannot be used on an internal song that contains a drum track, or on a song in which you recorded a drum performance using the QUICK REC function.	When you reselect the song, the drum performance you recorded using the QUICK REC function will be erased, and you will once again be able to use this function.

Main Specifications

Roland TD-15

Roland TD-11: Drum Sound Module

Drum Kits	TD-15	100	
	TD-11	50	
Effect Types	Ambience (10 types)		
	4-Band Equalizer		
	Multi Effect (10 types) *TD-15 ONLY		
Quick Rec	Resolution	480 ticks per quarter note	
	Recording Method	Real-time	
	Maximum Note Storage	approx. 30,000 Notes	
File Format	Audio File	WAV/MP3	
Illumination Ring *TD-15 ONLY	Dynamic, Kick, Tempo		
Display	64 x 128 dots Graphic Type LCD (backlit LCD)		
Connectors	TRIGGER INPUT connector (DB-25 type) (Kick, Snare, Tom1, Tom2, Tom3, Hi-Hat, Crash1, Ride, Ride Bell, Hi-Hat Control)		
	Extra Trigger Input jacks	TD-15	2 (CRASH2,AUX) (Stereo 1/4-inch phone type)
		TD-11	1 (CRASH2) (Stereo 1/4-inch phone type)
	OUTPUT jacks (L/MONO, R) (Stereo 1/4-inch phone type)		
	PHONES jack (Stereo 1/4-inch phone type)		
	MIX IN jack (stereo miniature phone type)		
	MIDI OUT connector		
	USB COMPUTER port		
	USB MEMORY port		
	Interface	Hi-Speed USB (USB-MIDI, USB-AUDIO, USB Flash Drive)	
Output Impedance	1.0 k ohms		
Power Supply	AC adaptor (DC 9V)		
Current Draw	TD-15	450 mA	
	TD-11	350 mA	
Dimensions	154 (W) x 89 (D) x 225 (H) mm		
	6-1/16 (W) x 3-9/16 (D) x 8-7/8 (H) inches		
Weight	TD-15	685 g / 1 lb 9 oz (excluding AC Adaptor)	
	TD-11	665 g / 1 lb 8 oz (excluding AC Adaptor)	
Accessories	Owner's Manual, AC Adaptor, Special Connection Cable, Wing Bolt (M5 x 10) x 2, Sound Module Mounting Plate, CD-ROM (Play-along Audio Song/USB Driver)		
Options (sold separately)	Pads (PD series, PDX series), Cymbals (CY series), Kick (KD series), Hi-Hat (VH-11), Hi-Hat Control Pedal (FD series), Stand (MDS series), Cymbal Mount (MDY series), Pad Mount (MDH series), Acoustic Drum Trigger (RT series), Personal Drum Monitor: PM-10, PM-30, V-Drums Accessory Package: DAP-3X, V-Drums Mat (TDM-20/TDM-10), USB Flash Drive		

* In the interest of product improvement, the specifications and/or appearance of this unit are subject to change without prior notice.

Index

A		L		S	
A-B repeat	29	link	17	saving	
ADVNCd	43	loading		drum kit	24
ambience	19	drum kit	25	Save Backup	38
send	21	Load Backup	39	selecting	
audio files	26			song	27
Auto Off	35			SEND	
B		M		ambience	21
basic	42	MENU screens	16	metronome	13, 36
Behavior Modeling Technology	5	MIDI	37	snare buzz	15
C		MIDI note number	22	song	
Coach mode	31	MIDI Visual Control	47	information	29
Computer	47	muffling	15	playing	27
copying		multi effects	19	selecting	27
drum kit or pad	23	N		settings	28
cross-stick	11, 12	naming		structure	26
D		drum kit	22	SONG screen	27
deleting		O		strainer	15
Delete Data	39	Options	35	SuperNATURAL	5
Display Brightness	35	P		SWITCH	
Display Contrast	35	pad		multi-effect	21
drum kit	11	copying	23	SYSTEM	34
copying	23	Pad Control	36	T	
creating	17	pad sensitivity	42	tempo	
loading	25	Pad Settings	41	metronome	13
naming	22	playing		trigger parameters	43
restoring	25	song	27	tuning	15
saving	24	power on/off	10	U	
DRUM KIT screen	11	previewing		USB driver	47
E		instrument	17	USB flash drive	24, 26
effects	19	Q		formatting	40
EQ	19	QUICK EDIT function	15	system	38
F		QUICK REC	14, 30	USB Memory	38
Factory Reset	46	R		V	
folder	14, 28, 30	recording	14	V-Drums Friend Jam	47
formatting		restoring		V-Drums Tutor	47
USB flash drive	40	drum kit	25	Video Device	47
FX	19	factory settings	46	V-LINK	47
FX parameter list	20	rim	11	volume	
H		link	17	drum kit	18
head	11	S		metronome	13
link	17	I			
I		information			
song	29	song	29		
TD	46	TD	46		
USB flash drive	40	USB flash drive	40		
INST EDIT parameter list	18	instrument	11		
instrument	11	changing	17		
changing	17	editing	18		
editing	18	previewing	17		
previewing	17				

MEMO

有关产品中所含有害物质的说明

本资料就本公司产品中所含的特定有害物质及其安全性予以说明。

本资料适用于 2007 年 3 月 1 日以后本公司所制造的产品。

环保使用期限



此标志适用于在中国国内销售的电子信息产品，表示环保使用期限的年数。所谓环保使用期限是指在自制造日起的规定期限内，产品中所含的有害物质不致引起环境污染，不会对人身、财产造成严重的不良影响。

环保使用期限仅在遵照产品使用说明书，正确使用产品的条件下才有效。

不当的使用，将会导致有害物质泄漏的危险。

产品中有毒有害物质或元素的名称及含量

部件名称	有毒有害物质或元素					
	铅(Pb)	汞(Hg)	镉(Cd)	六价铬(Cr(VI))	多溴联苯(PBB)	多溴二苯醚(PBDE)
外壳(壳体)	×	○	○	○	○	○
电子部件(印刷电路板等)	×	○	×	○	○	○
附件(电源线、交流适配器等)	×	○	○	○	○	○

○：表示该有毒有害物质在该部件所有均质材料中的含量均在 SJ/T11363-2006 标准规定的限量要求以下。
 ×：表示该有毒有害物质至少在该部件的某一均质材料中的含量超出 SJ/T11363-2006 标准规定的限量要求。
 因根据现有的技术水平，还没有什么物质能够代替它。

For EU Countries



UK This symbol indicates that in EU countries, this product must be collected separately from household waste, as defined in each region. Products bearing this symbol must not be discarded together with household waste.

DE Dieses Symbol bedeutet, dass dieses Produkt in EU-Ländern getrennt vom Hausmüll gesammelt werden muss gemäß den regionalen Bestimmungen. Mit diesem Symbol gekennzeichnete Produkte dürfen nicht zusammen mit dem Hausmüll entsorgt werden.

FR Ce symbole indique que dans les pays de l'Union européenne, ce produit doit être collecté séparément des ordures ménagères selon les directives en vigueur dans chacun de ces pays. Les produits portant ce symbole ne doivent pas être mis au rebut avec les ordures ménagères.

IT Questo simbolo indica che nei paesi della Comunità europea questo prodotto deve essere smaltito separatamente dai normali rifiuti domestici, secondo la legislazione in vigore in ciascun paese. I prodotti che riportano questo simbolo non devono essere smaltiti insieme ai rifiuti domestici. Ai sensi dell'art. 13 del D.Lgs. 25 luglio 2005 n. 151.

ES Este símbolo indica que en los países de la Unión Europea este producto debe recogerse aparte de los residuos domésticos, tal como está regulado en cada zona. Los productos con este símbolo no se deben depositar con los residuos domésticos.

PT Este símbolo indica que nos países da UE, a recolha deste produto deverá ser feita separadamente do lixo doméstico, de acordo com os regulamentos de cada região. Os produtos que apresentem este símbolo não deverão ser eliminados juntamente com o lixo doméstico.

NL Dit symbool geeft aan dat in landen van de EU dit product gescheiden van huishoudelijk afval moet worden aangeboden, zoals bepaald per gemeente of regio. Producten die van dit symbool zijn voorzien, mogen niet samen met huishoudelijk afval worden verwijderd.

DK Dette symbol angiver, at i EU-lande skal dette produkt opsamles adskilt fra husholdningsaffald, som defineret i hver enkelt region. Produkter med dette symbol må ikke smides ud sammen med husholdningsaffald.

NO Dette symbolet indikerer at produktet må behandles som spesialavfall i EU-land, iht. til retningslinjer for den enkelte regionen, og ikke kastes sammen med vanlig husholdningsavfall. Produkter som er merket med dette symbolet, må ikke kastes sammen med vanlig husholdningsavfall.

SE Symbolen anger att i EU-länder måste den här produkten kasseras separat från hushållsavfall, i enlighet med varje regions bestämmelser. Produkter med den här symbolen får inte kasseras tillsammans med hushållsavfall.

FI Tämä merkintä ilmaisee, että tuote on EU-maissa kerättävä erillään kotitalousjätteistä kunkin alueen voimassa olevien määräysten mukaisesti. Tällä merkinnällä varustettuja tuotteita ei saa hävittää kotitalousjätteiden mukana.

HU Ez a szimbólum azt jelenti, hogy az Európái Unióban ezt a terméket a háztartási hulladékotól elkülönítve, az adott régióban érvényes szabályozás szerint kell gyűjteni. Az ezzel a szimbólummal ellátott termékeket nem szabad a háztartási hulladék közé dobni.

PL Symbol oznacza, że zgodnie z regulacjami w odpowiednim regionie, w krajach UE produktu nie należy wyrzucać z odpadami domowymi. Produktów opatrzonych tym symbolem nie można utylizować razem z odpadami domowymi.

CZ Tento symbol udává, že v zemích EU musí být tento výrobek sbírán odděleně od domácího odpadu, jak je určeno pro každý region. Výrobky nesoucí tento symbol se nesmí vyhazovat spolu s domácím odpadem.

SK Tento symbol vyjadruje, že v krajinách EÚ sa musí zber tohto produktu vykonávať oddelene od domového odpadu, podľa nariadení platných v konkrétnej krajine. Produkty s týmto symbolom sa nesmú vyhazovať spolu s domovým odpadom.

EE See sümbol näitab, et EL-i maades tuleb see toode olemprigüst eraldi koguda, nii nagu on igas piirkonnas määratletud. Selle sümboliga märgitud tooteid ei tohi ära visata koos olmeprügiga.

LT Šis simbolis rodo, kad ES šalyse šis produktas turi būti surenkamas atskirai nuo buitinių atliekų, kaip nustatyta kiekviename regione. Šiuo simboliu paženklinoti produktai neturi būti išmetami kartu su buitiniams atliekomis.

LV Šis simbols norāda, ka ES valstīs šo produktu jāievāc atsevišķi no mājsaimniecības atkritumiem, kā noteikts katrā reģionā. Produktus ar šo simbolu nedrīkst izmest kopā ar mājsaimniecības atkritumiem.

SI Ta simbol označuje, da je treba proizvod v državah EU zbirati ločeno od gospodinskih odpadkov, tako kot je določeno v vsaki regiji. Proizvoda so tem znakom ni dovoljeno odlagati skupaj z gospodinskimi odpadki.

GR Το σύμβολο αυτό υποδηλώνει ότι στις χώρες της Ε.Ε. το συγκεκριμένο προϊόν πρέπει να συλλέγεται χωριστά από τα υπόλοιπα οικιακά απορρίμματα, σύμφωνα με όσα προβλέπονται σε κάθε περιοχή. Τα προϊόντα που φέρουν το συγκεκριμένο σύμβολο δεν πρέπει να απορρίπτονται μαζί με τα οικιακά απορρίμματα.

For the USA

DECLARATION OF CONFORMITY Compliance Information Statement

Model Name : TD-15/TD-11
Type of Equipment : Sound Module
Responsible Party : Roland Corporation U.S.
Address : 5100 S. Eastern Avenue, Los Angeles, CA 90040-2938
Telephone : (323) 890-3700

For EU Countries



This product complies with the requirements of EMC Directive 2004/108/EC.

For the USA

FEDERAL COMMUNICATIONS COMMISSION RADIO FREQUENCY INTERFERENCE STATEMENT

This equipment has been tested and found to comply with the limits for a Class B digital device, pursuant to Part 15 of the FCC Rules. These limits are designed to provide reasonable protection against harmful interference in a residential installation. This equipment generates, uses, and can radiate radio frequency energy and, if not installed and used in accordance with the instructions, may cause harmful interference to radio communications. However, there is no guarantee that interference will not occur in a particular installation. If this equipment does cause harmful interference to radio or television reception, which can be determined by turning the equipment off and on, the user is encouraged to try to correct the interference by one or more of the following measures:

- Reorient or relocate the receiving antenna.
- Increase the separation between the equipment and receiver.
- Connect the equipment into an outlet on a circuit different from that to which the receiver is connected.
- Consult the dealer or an experienced radio/TV technician for help.

This device complies with Part 15 of the FCC Rules. Operation is subject to the following two conditions:

- (1) this device may not cause harmful interference, and
- (2) this device must accept any interference received, including interference that may cause undesired operation.

This equipment requires shielded interface cables in order to meet FCC class B limit.

Any unauthorized changes or modifications not expressly approved by the party responsible for compliance could void the user's authority to operate the equipment.

For Canada

NOTICE

This Class B digital apparatus meets all requirements of the Canadian Interference-Causing Equipment Regulations.

AVIS

Cet appareil numérique de la classe B respecte toutes les exigences du Règlement sur le matériel brouilleur du Canada.

For C.A. US (Proposition 65)

WARNING

This product contains chemicals known to cause cancer, birth defects and other reproductive harm, including lead.

For the U.K.

IMPORTANT: THE WIRES IN THIS MAINS LEAD ARE COLOURED IN ACCORDANCE WITH THE FOLLOWING CODE.

BLUE: NEUTRAL
BROWN: LIVE

As the colours of the wires in the mains lead of this apparatus may not correspond with the coloured markings identifying the terminals in your plug, proceed as follows:

The wire which is coloured BLUE must be connected to the terminal which is marked with the letter N or coloured BLACK.
The wire which is coloured BROWN must be connected to the terminal which is marked with the letter L or coloured RED.
Under no circumstances must either of the above wires be connected to the earth terminal of a three pin plug.

Roland

